

Reliable dosing of chemicals

Motor-driven diaphragm dosing pumps play an important role in the reliable and accurate dosing of liquids in process cycles. They are appropriate for low-pressure applications and high dosing quantities.

Dosing pumps are used in many branches of industry that work with liquid chemicals - not excluding toxic and highly-aggressive media.

Riding on the crest of the waves

Two sizes of the MEMDOS LP series are available. A large coverage in terms of performance and resistance is available, thanks to the variety of dosing heads, combined with a wide range of dosing head materials.

The performance ranges up to 41 gph for the first size, up to 270 gph for the second size. The maximum permitted pressure, depending on the size, is between 58 and 232 psig.

Thanks to the sturdy tappet drive with manual or automatic capacity adjustment, the conveyed media such as acids, lyes, coagulants and flocculants are dosed reliably and precisely.

On request, the MEMDOS LP pumps can also be supplied with a double-diaphragm system. Then uncontrolled leakage of media is avoided even if the dosing diaphragm wears out.

Versatile and flexible

The MEMDOS LP is used when the integration of the pump into controls or control circuits is required. For integration into demanding automation networks, a version with an Ethernet-based MODBUS interface is available.

The MEMDOS LP doesn't just impress with its elegant design; the graphical display with a multi-language menu as well as the dosing pump's operation using the integrated keyboard simplifies its use.

If required, the dosing pump can be controlled via an analogue or pulse input. To react to any variations in the control circuit, the pump has many additional functions; stroke remote reporting, external operation consent, level monitoring, fault reporting via a relay as well as diaphragm rupture monitoring.



In Short

- Capacity range up to 270 gph, at up to 232 psig
- Minor dependence of the backpressure
- Graphical display with multi-language menu
- Precise pump adjustments using the keyboard
- Supply amount displayed in various units
- Infinitely variable stroke frequency from 0 to 100%
- Calibration functionality
- External control via standard signal 0/4 – 20 mA
- External control via floating contacts with impulse increase and reduction
- Materials available: PVC, PP, PVDF and stainless steel
- Diaphragm breakage detection and reporting (optional)
- Compact design, low space requirement
- Material consistency for the pumps and accessories
- Double-diaphragm system (optional)
- Ethernet interface (optional)
- Batch dosing with interval and timer function

Technical Data

MEMDOS LP		4	4-HP	10	10HP	20	20HP	35	60	80	150
Delivery capacity at maximum backpressure (50/60 Hz)	gph	1.1	2.2	3.7	6.0	5.8	9.6	9.5	16.7	24	41
Max. supply pressure	psig	174	232	174	232	174	232	145		72	
Max. stroke frequency (50/60 Hz)	SPM	26	26	72	72	120	120	72	120	72	120
Suction head for non-gassing media	feet H ₂ O	29				26				23	
Max. supply pressure	psi	7.3 PSI									
Stroke length	inch	0.3"						0.4"			
Stroke volume	ml/stroke	2.7	5.4	2.7	5.4	2.7	5.4	8.6	8.6	19.3	21.4
Nominal valve width		DN4						DN6		DN10	
Voltage supply		230V									
Motor efficiency		Greater than 90% (energy efficiency class IE4)									
Protection class		IP 55									
Insulation class		F									
Weight (without a motor)	PVC	24						27			
	PP	24						27			
	PVDF	24						30			
	14571	27						38			
Max. ambient temperature	°F	41-113°F (104°F with PVC parts)									
Max. temperature of the medium	°F	176°F (with PVC parts 95°F; with PP parts 140°F)									

MEMDOS LP		110	160	210	260	310	400	510	760	1010	
Delivery capacity at maximum backpressure (50/60 Hz)	gph	30	38	56	70	78	103	133	197	270	
Max. supply pressure	psig	145				116	87	58		44	
Max. stroke frequency (50/60 Hz)	SPM	96	120	96	120	96	120	53	76	107	
Suction head for non-gassing media	feet H ₂ O	23		19		14		3			
Max. supply pressure	psi	7.3 PSI									
Stroke length	inch	0.4"						0.5"			
Stroke volume	ml/stroke	2.7	5.4	2.7	5.4	2.7	5.4	8.6	8.6	19.3	
Nominal valve width		DN10		DN15				DN25			
Voltage supply		230V									
Motor efficiency		Greater than 90% (energy efficiency class IE4)									
Protection class		IP 55									
Insulation class		F									
Weight (without a motor)	PVC	43.4		45.6		50		67.2			
	PP	43.4		45.6		50		67.2			
	PVDF	44.1		46.7		51.5		71			
	14571	55		64.5		75.8		115			
Max. ambient temperature	°F	41-113°F (104°F with PVC parts)									
Max. temperature of the medium	°F	176°F (with PVC parts 95°F; with PP parts 140°F)									

Flow curves

The flow curves are valid for ambient temperatures of 68 °F (20 °C) and dosing water at 100% stroke frequency. The delivery capacities depend on the medium (density and viscosity) and temperature.

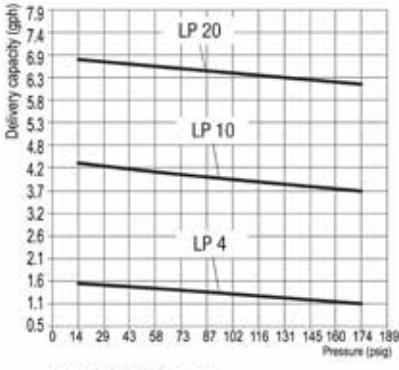

MEMDOS 4-10-20

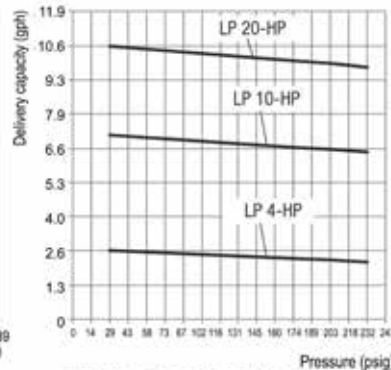

MEMDOS 4-HP-10-HP-20-HP

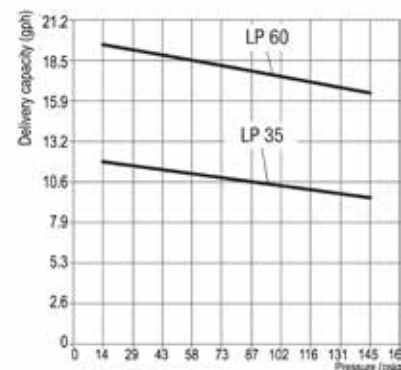

MEMDOS 35-60

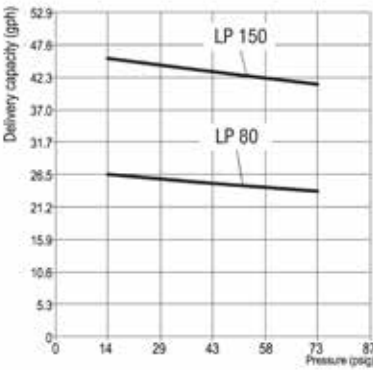

MEMDOS 80-150

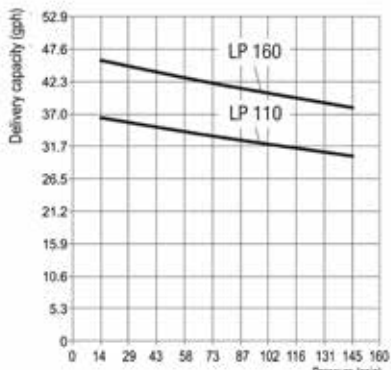

MEMDOS 110-160

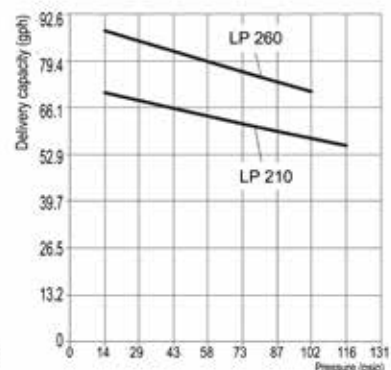

MEMDOS 210-260

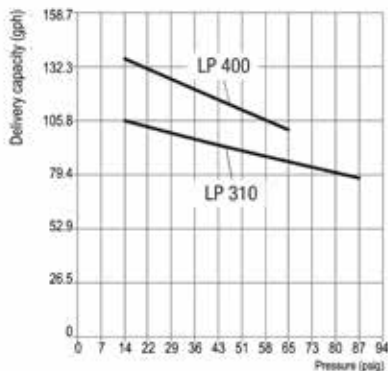

MEMDOS 310-400

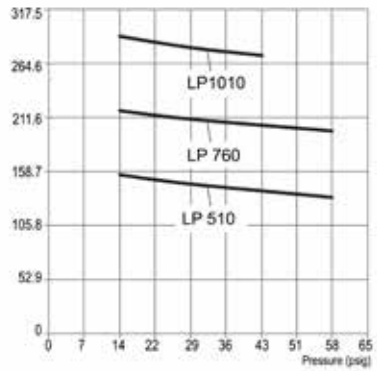

MEMDOS 510-760-1010

Dimensions

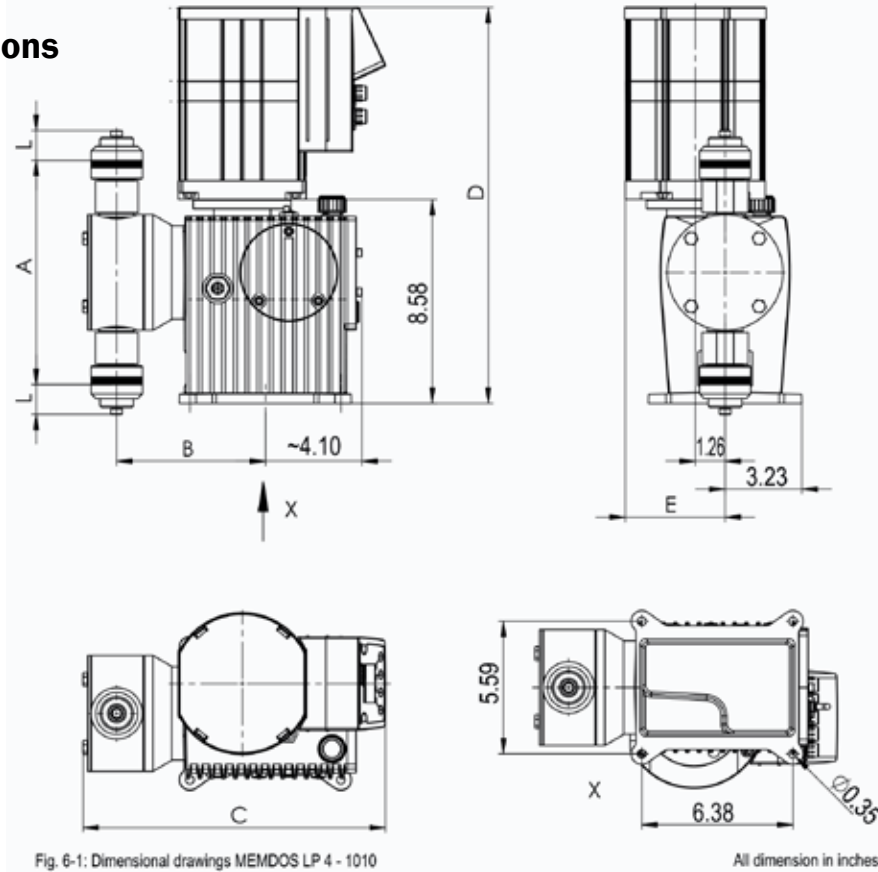

Fig. 6-1: Dimensional drawings MEMDOS LP 4 - 1010

All dimension in inches

Accessories

Suitable sets of accessories, which consists of a suction line, a pressure line and an injection nozzle, are available for the dosing pumps. Even the best pump can still be improved - namely by the right technical periphery. To make your dosing pump into an efficient dosing system, we recommend using the following accessories:

- Injection nozzles – to dose the medium in the main line and to prevent it flowing back into the pressure line
- Pressure loading and relief valves – to increase dosing accuracy or to protect the system against too high a pressure
- Pulsation dampener – to damp supply currents as well as to reduce the flow resistance in long pipelines.
- Priming aids – to significantly ease priming of dosing pumps with low supply volumes per stroke, for large suction heights, for highly-viscous dosing media or for initial priming or when priming after the system has been laying idle
- Suction pressure regulator – to prevent medium flow when the dosing pump is not running or to prevent a vacuum being formed in the event of a pipe burst

Size	4-20	35-60	80, 150	110, 160
A	4.96	5.87	9.80	9.80
B	4.57	4.78	5.24	6.30
C	10.87	11.14	12.09	12.80
D	16.22	16.22	16.22	16.93
E	3.90			4.21
L	Depends on the connection type and size			
Size	210-260	310-400	510-1010	
A	10.55	12.30	13.86	
B	6.69	6.89	7.28 (6.83*)	
C	13.19	13.39	14.37 (13.33*)	
D	16.93	16.93	18.11	
E	4.21			
L	Depends on the connection type and size			

* with dosing head of stainless steel
All dimensions in inches

For further accessories for your dosing pump, please refer to our dosing pump brochure.