

TOPAX® DE
Two-Channel Controller



EN 01

Operating instructions

Read this operating manual before using the equipment.
To be retained for future reference.

Table of Contents

1 Safety Instructions	3	10 Analogue power outputs 0/4 ... 20 mA for remote displays	28
1.1 General	3	11 Log book function.....	28
1.2 Identification of safety instructions in the operating manual	3	12 Menu configuration and main settings.....	29
1.3 Personnel qualification and training.....	3	12.1 Menu of TOPAX.....	29
1.4 Electrical device safety instructions	3	13 Default settings	37
1.5 Hazards due to non-compliance with the safety instructions	3	14 Memory card.....	37
1.6 Working in a safety-conscious manner	3	15 Troubleshooting and diagnostics.....	38
1.7 Safety instructions for the operator.....	3	15.1 Self-setting alarms.....	38
1.8 Safety instructions for installation, maintenance and inspection.....	4	15.2 Displays that must be confirmed with "OK".....	38
1.9 Modifications and obtaining spare parts	4	15.3 Remedy.....	38
2 Before using the equipment.....	4	16 terminal connection diagram for own configurations	39
2.1 Use for intended purpose.....	4	16.1 measurands	39
2.2 Scope of delivery	4	16.2 Output types.....	39
2.3 Steps to take for start-up.....	4	17 Device revision	40
3 Technical data.....	5	18 Warranty claim.....	41
3.1 Recommended cables.....	6	19 EC Declaration of Conformity	42
4 Assembly and Installation.....	7	20 Index	43
4.1 General Notes.....	7		
4.2 Dimensions	7		
4.3 Wall assembly.....	7		
4.4 Technical components.....	8		
4.5 Power connections.....	9		
4.6 TOPAX on the EASYPRO water sampling station	10		
4.7 Terminal clips of the main board and the technical components	11		
4.8 Input configuration	13		
4.9 Output configuration.....	14		
4.10 Operation and keyboard layout.....	17		
4.11 First set-up and programming guidelines.....	17		
4.12 Next steps	19		
5 Measuring values inputs.....	19		
5.1 Measurement input Disinfection (amperometric measurement cells).....	20		
5.2 pH value measurement input	21		
5.3 Measurement output Redox potential	23		
5.4 Temperature measurement input.....	23		
6 Explanation of digital signal inputs	24		
6.1 Start-up delay.....	24		
6.2 Deactivation of the controller function with alarm signaling in the case of lack of sample water.....	24		
6.3 Low level alert, alarm and warning "level dosing pump"	24		
7 Explanation of measuring values outputs	24		
7.1 General	24		
7.2 Output types.....	24		
7.3 Output restriction	25		
7.4 Actuator	25		
8 Controller explanation	25		
8.1 Definitions	25		
8.2 Proportional controller (P controller).....	25		
8.3 Proportional-integral-derivative controller (PI, PID controller)	25		
8.4 Calculation of settable values.....	26		
8.5 Controller parameters.....	27		
8.6 Control direction	27		
8.7 Basic load dosing.....	27		
8.8 Manual mode	27		
9 Alarms.....	27		
9.1 Measurement alarms	27		
9.2 Safety cutout (Y alarm)	27		

1 Safety Instructions

1.1 General

This manual contains essential information for the installation, start-up, operation and maintenance of the equipment. Please have your staff and any person in charge of the unit read and understand this manual before starting any work with it. Store this manual safely in a place where mechanics, installers and other technical staff as well as operators can rapidly access it in case of emergency. Attention must also be paid to all the safety instructions in this manual.

1.2 Identification of safety instructions in the operating manual

This operating manual contains essential safety instructions. Failure to observe this information may endanger other people and the unit. The safety instructions are identified by the following symbols:



WARNING!

Refers to a potentially hazardous situation. Failure to follow this instruction may lead to death or severe injury.



CAUTION!

Refers to a potentially hazardous situation. Failure to follow this instruction may lead to minor injury or damage to property.



ATTENTION! or NOTICE!

Failure to comply with this safety instruction may result in damage to the device and endanger its operation.



IMPORTANT!

This refers to additional information to facilitate operation and ensure the smooth running of the equipment. Appropriate reference attached directly on the unit or any of its other parts must absolutely be considered and held in completely readable condition for future reference.

1.3 Personnel qualification and training

Your installation, operation, maintenance and inspection staff must be trained and qualified for these tasks. Personnel areas of responsibility, tasks and supervision must be controlled and ensured by the operating company at all times. Unskilled personnel must be trained and instructed. If necessary, this can also be performed by the manufacturer or certified supplier on behalf of the operating company. The operating company must also ensure that the operating manual has been understood.

1.4 Electrical device safety instructions

Basic safety precautions should always be followed when installing and using this electrical equipment. These include the following:



WARNING!

- 1.) *Read and follow all instructions.*
- 2.) *To reduce the risk of injury, do not permit children to use this product unless they are closely supervised at all times.*
- 3.) *Risk of electric shock. Ensure that the device is secured with a ground fault - circuit breaker (GFCI = earth-leakage circuit breaker). Contact a qualified electrician if you cannot verify whether the connection is protected by a GFCI.*
- 4.) *Do not bury cord. Fix the cable to minimise possible damage due to lawn mowers, hedge trimmers, and other equipment.*
- 5.) *To reduce the risk of electric shock, replace the cable immediately if damaged.*
- 6.) *To reduce the risk of electric shock, do not use an extension cable to connect the device to the power supply; use an appropriately located socket.*
- 7.) *Keep these instructions for future reference.*

1.5 Hazards due to non-compliance with the safety instructions

Failure to comply with the safety instructions may endanger not only people, but also the environment and the unit. Failure to follow the safety instructions will invalidate any damage claims.

The following hazards in particular may arise: Failure of major functions of the device. - Danger to persons from electrical, mechanical and chemical influences. Danger to the environment due to leakage of hazardous substances.

1.6 Working in a safety-conscious manner

The safety instructions contained in this operating manual must be observed. The operating company is responsible for ensuring compliance with local safety regulations. Any faults that could affect safety must be rectified immediately.

1.7 Safety instructions for the operator

Statutory regulations must be observed. Consumables and replacement parts must be disposed of safely and in an environmentally friendly manner. Avoid possible hazards from electric current (for further details refer to section 1.4).

1.8 Safety instructions for installation, maintenance and inspection

The operating company must ensure that all installation, maintenance and inspection work is carried out by qualified and authorised personnel.



WARNING!

Installation and maintenance work on the equipment must only be carried out after the device has been disconnected from the power supply. The device must be prevented from being switched on again during the above work. Auxiliary modules should be fitted/removed in this condition. Cables should also only be attached in this condition.



ATTENTION!

Before opening the device, ensure that it cannot suffer damage through electrostatic discharge. The fitter is to perform all necessary measures to this end (e.g. touch a metal conductor which is grounded). Use ESD-compliant, conducting tools when changing electronics components and connecting the cable. Wherever possible, avoid contact with electronic components with bare hands or uninsulated tools.

Neglecting of these instructions can lead to severe damages of TOPAX and loss of warranty.

All safety mechanisms and guards must be refitted and reactivated as soon as the work is completed.



ATTENTION!

As well as faulty installation, incorrect controller settings (setpoint, parameter and configuration level data, and device-internal modifications) can impair the process or result in damage.

There should always be a safety device independent of the controller. Configurations may only be carried out by technical personnel! If necessary use password protection. Always comply with the safety regulations of the country of use.

1.9 Modifications and obtaining spare parts

TOPAX may be converted or changed only by qualified technical personnel.

If the configuration of the TOPAX is wrongly made by assembly or service personnel, errors and dangers in the function of the machine can result. In this case, the manufacturer declines any liability.



ATTENTION!

Only genuine manufacturer spare parts and sensors may be used. Failure to comply will invalidate the warranty.

2 Before using the equipment

2.1 Use for intended purpose

The TOPAX is exclusively designed and meant for metering and control applications in water treatment plants and waste water management. The operational safety of the unit can only be ensured if used according to its purpose.

All other types of use are prohibited and will invalidate the warranty.

2.2 Scope of delivery

Carefully check the delivery prior to installation and refer to the delivery note to ensure the delivery is complete and to check for any transport damage. Contact the supplier and/or carrier regarding any questions concerning the delivery and/or transport damage.

Do not operate defective devices.

The scope of delivery includes:

- TOPAX casing (as per the model)
- Tool (M4 screw) to open the casing
- Memory card
- Mounting material
- Operating instructions
- Measuring protocol
- Terminal plan for the sensors
- Electrodes (optional)
- Cable connection TOPAX to the electrodes (optional)

The device is delivered either as detached or mounted onto a measuring water table.

2.3 Steps to take for start-up

The following steps are recommended by the manufacturer in order to install the TOPAX successfully:

- Reading the operating instructions
- Installing the device
- Attach the sensors and actuating element (to the controlling pumps and switch, etc.)
- Calibrate the sensors to the measuring output
- Adjusting the input measuring ranges
- Controller explanation
- Configuration of the regulating output

3 Technical data

Supply voltage	90 ... 264 V AC, 47 ... 63 Hz	
Power consumption	Approx. 24 W	
Housing dimensions	302 x 231 x 108 mm (W x H x D) wall-mounted housing	
Display	Graphic colour display 5.7 inch, 320 * 240 pixels (RGB), with LED backlight (lighting dims automatically after 10 minutes)	
Keyboard	Keyboard with touch keys	
Measurement inputs (potential-free)	Inputs for disinfection, pH value, REDOX potential, temperature	
Control characteristic for 2 inputs (disinfection, pH value)	P, PI, PD or PID performances Fixed value regulation, standard channel selectable with disturbance variable feed forward 2-side controller	
Control parameters	Xp: 1...500%, Tn: 1...200 minutes, Tv: 1...1200 seconds	
Measurement input Disinfection	Open amperimetric electrode with mechanical cleaning (excess chlorine detector with 2 electrodes, CS 120) Measuring range adjustable from: 0-1,00 mg/l, 0-2,00 mg/l, 0-5,00 mg/l oder 0-10,00 mg/l. Connection via series terminals*	
	Potentiostat (PM) Measuring range adjustable from: 0-1,00 mg/l or 0-2,00 mg/l	
	Encapsulated electrode	20 mA type with supply of the measuring cell (24 VDC), measuring range depending on measuring cells Measuring range adjustable from: 0 – 1,00 mg/l, 0 – 2,00 mg/l or 0 – 10,00 mg/l
Measuring input for pH value	Measuring range pH 0 ... 14	Connection via series terminals*
REDOX potential measuring input (for disinfection)	Measuring range 0 ... 1000 mV	Connection via series terminals*
Temperature measuring input - Pt 100	Measuring range -10°C ... +100°C	Two-leader connection by means of line-up terminals*
Total chlorine measuring input	Encapsulated electrode	Measuring range adjustable from: 0 – -1,00 mg/l, 0 – 2,00 mg/l or 0 – 10 mg/l
Disturbance variable input (optionally available)	0...20 mA or 4...20 mA Disturbance factor: 0.1 ... 10 times amplification	
Digital inputs	<ul style="list-style-type: none"> - Low level alert input for metering pump 1 - Alarm level input for metering pump 1 - Low level alert input for metering pump 2 - Alarm level input for metering pump 2 - Measuring water shortage disconnection of the regulating function with alarm (external switch off) 	
Controller outputs	Electronic output (optocouplers)	- 48 V DC; 250 mA (Pulse frequency 10 ... 350 Impulses/min)
	Relay output	- ON/OFF - Pulse frequency 10 ... 100 Impulses/min - Pulse length 10 ... 3600 seconds - 3-point step output with - Position feedback value of the Potentiometer 1 ... 10 kOhm
	Continuous output	0/4...20 mA, max. load 500 ohms
Alarm output	Relay output as collective alarm for the measuring size of Disinfection, pH value, redox potential, temperature and conductivity as potential free changer	
	Measurement alarm	Min. and max. alarm freely adjustable, time delay adjustable: max. 200 min
	Safety cutout	To prevent over metering (Y-alarm), time delay adjustable: max. 200 minutes
Current outputs for remote transmission of measuring values - Disinfection - pH value - Redox potential - Temperature	0/4 ... 20 mA possible spreading; max. load 500 ohms potential free	
	Useful spreading	>50 % with measuring input Disinfection and 0/4 ... 20 mA >10% during measurement input of pH-value and redox potential
Computer interface (optional)	RS 485	
Load capacity of the relay	230 V AC, 3A	
Protection class	IP 65 with locked screw connections	
Ambient temperature	-5°C ... +45°C	
Air humidity	95 % non-condensing	

*) max. 0.5 mm² with cable end sleeve and max. 1.0 mm² without cable end sleeve.

3.1 Recommended cables

Recommended cables for the different connections and applications:

Connections and applications	Dimensions	Types
Mains voltage	M20 X 1.5	NYM-I 3 x 1.5 mm (9.1 mm)
Relay output (ATE- engine)	M20 X 1.5	NYM-I 4 x 1.5 mm (9.8 mm)
Relay output (pulse frequency), (pulse length)	M16 X 1.5	NYM- O 2x 1.5 mm (8.7 mm)
Relay output alarm)	M16 X 1.5	NYM- O 3x 1.5 mm (9.1 mm)
connection to PC, computer cable Cat 5	M12 X 1.5	Type 2X2XAWG24/1 (5.7 mm)
Connection of current outputs (remote communication cable)	M12 X 1.5	J-Y (St) Y 4 x2x0,6 mm (6.5 mm)
Position feedback ATE- engine (remote communication cable)	M12 X 1.5	J-Y (St) Y 2x2x0.6 mm (5.0 mm)
Continuous controller output (remote communication cable)	M12 X 1.5	J-Y (St) Y 2x2x0.6 mm (5.0 mm)
Input measuring cell	M12 X 1.5	LIYY 2x 0.25 mm
Digital inputs (for each input) (remote communication cable)	M12 X 1.5	J-Y (St) Y 2x2x0.6 mm (5.0 mm)

4 Assembly and Installation

4.1 General Notes

For installation, the local directions and regulations have to be adhered to. Any mounting position is possible. The ambient conditions are to be maintained in accordance with the technical data. Exposure of the unit to direct heat and sunlight must be avoided.

4.1.1 Diagram TOPAX housing

The TOPAX device is composed of two parts, a rear and a front housing. The rear shell of the housing is electrically connected with a flat cable with the front one.

The front housing ① and the rear housing ② of the controller are fitted together with two pivots (③ and ④). The unit is designed so that the controller can be opened from either side.

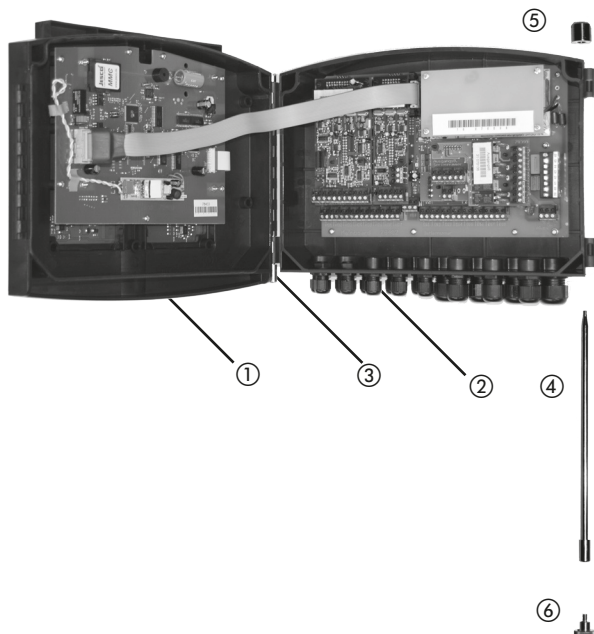

- ① Front housing
- ② Rear housing
- ③ Hinge pivot (fitted)
- ④ Hinge pivot (disassembled)
- ⑤ Pivot head (unscrewed)
- ⑥ Pivot disassembly tool

4.1.2 Opening the housing

To open the housing it is preferable to remove the right pivot. To do this, unscrew head ⑤ of the pivot. The pivot disassembly tool ⑥ serves the purpose.



ATTENTION!

In order to open the housing remove only one pivot from the equipment. If both pivots are removed at the same time, the front housing will no longer be attached to the bottom section.



ATTENTION!

The equipment must only be opened when it is disconnected from the power supply.

4.2 Dimensions

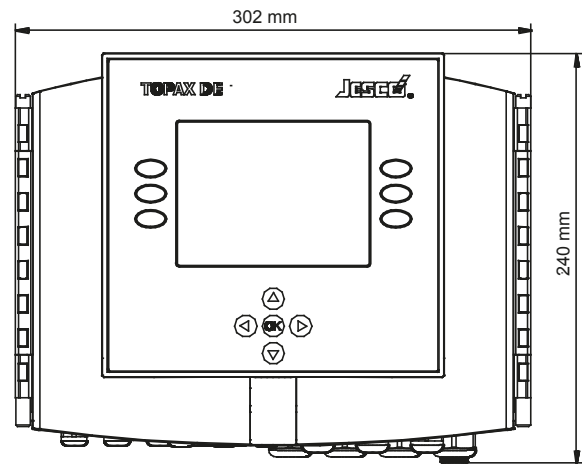

Fig.1: Dimensions TOPAX

4.3 Wall assembly

For the wall assembly 4 mounting holes are to be found in the lower part of the housing. The hardware for wall fixation is provided with the unit by the manufacturer.

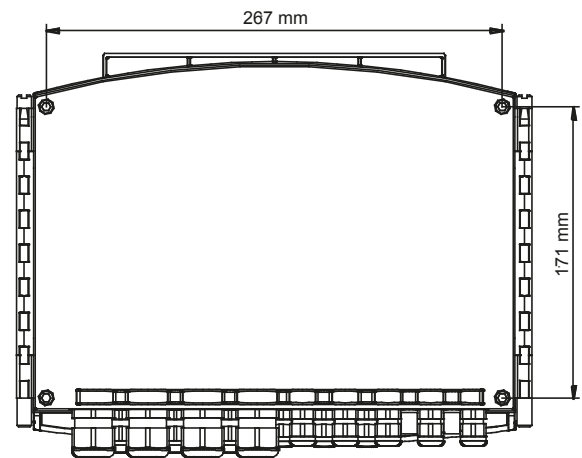

Fig.2: Spacing of hole for mounting the device

4.3.1 Rear housing

consists of rear housing with the motherboard, in which the cable connections are screwed in.

On the motherboard there are the main modules for the functioning. Depending upon the model, two input assemblies are available together with one output assembly. For networking purposes with connection to a PC, an additional interface (RS485) is available. All assemblies are attached to the main board by plug connectors and fastened with several nuts.

4.3.2 Front housing

The front housing contains the display board and the keyboard. A colour display is included to show measurements and allow for adjustment. The operation takes place with 6 function keys as well as a control cross with "OK" key. The keys are integrated in a keyboard and react to contact. All displays of the individual menus appear as plain text.

4.4 Technical components

Besides the main board, the following can be fitted in addition

- up to 2 input components
- an output component and
- an Interface module (RS 485)

To operate the TOPAX at least one entry component has to be built in.

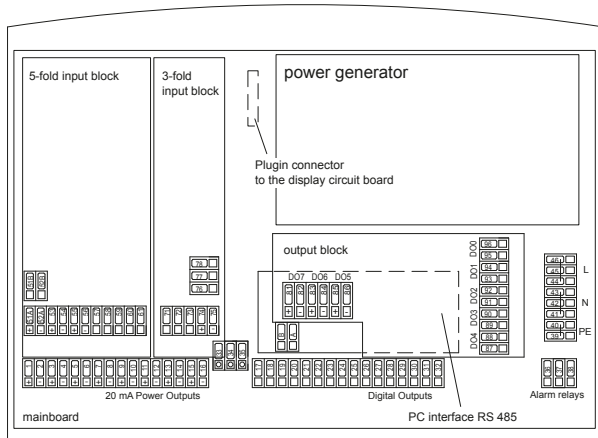

Fig.3: Arranging the components on the main board

4.4.1 Main board

Besides this function, to incorporate the further components, the main board is made up of the following connections:

- 5 analogue power inputs (0/4 ... 20mA)
- 5 digital inputs
- Alarm relay
- power supply

4.4.2 5-fold Input block

with 5 measurement inputs for:

- Disinfection (single amperimetric electrode or encapsulated electrode) (0/4...20 mA)
- pH single-rod measuring cell
- Redox single-rod measuring cell
- Temperature sensor Pt100
- Position feedback of a servo motor with potentiometer

4.4.3 3-fold Input block

with 3 measurement inputs for:

- Disinfection (potentiostatic measuring cell)
- Position feedback of a servo motor with potentiometer
- 0/4 20 mA power entrance for the connection of a disturbance variable

4.4.4 Output board

On the output block there are 5 integrated relay output and 3 electronic outputs (optocouplers).

The following output can be configured:

- Control output Disinfection with various output functions
- Control output pH-value with various output functions

The software configuration automatically assigns these outputs to the respective terminals in a sequential order- depending on the configuration of the TOPAX:

1. Disinfection controller
2. Controller pH value

Depending upon output type, TOPAX selects the next free relay output or optocoupler. The clamps are assigned in a firm order: clamps 87/88 to 95/96 for relays, or 81/82 bis 85/86 for optocouplers.



NOTE!

For further information on the terminal connection, refer to section "4.7 Terminal clips of the main board and the technical components" on page 11.

4.4.5 Interface board RS 485

The TOPAX has the option of being fitted with a serial interface RS 485. The RS 485 allows you to transfer data to a PC. The MODBUS protocol serves as data transmission protocol.

With the RS 485 interface it is possible to connect more than one TOPAX to a network. For this an address is to be assigned to each TOPAX. In addition to this each TOPAX is fitted with a computer-interface RS 485.

It is possible to have a maximum of 1000 m of data transfer with the RS 485 interface. Up to 14 TOPAXs can be connected to a network with a PC.



ATTENTION!

The data line is to be attached direct to the connecting terminals of the TOPAX (clip A and B, see Fig.4). Separate external connection or distribution boxes must not be set. The network address 10 is not permitted.



IMPORTANT!

For the realization of a network with the TOPAX and the structure of a bus system to a PC a computer cable "KAT.5 type 2X2XAWG24/1 (Lapp cable)" or better is to be used. Using other cables can cause data errors and affect the data transmission. The manufacturer is not liable for this.

Most modern computers are equipped with the serial computer interface R-S 232 and/or with USB - interfaces. For the connection to a RS 485 network, an additional connector converter (RS 485 to RS 232 or RS 485 to USB) is necessary.

There are interface components in the under casing part of the main board in the TOPAX. It is partially hidden from view by the output module.

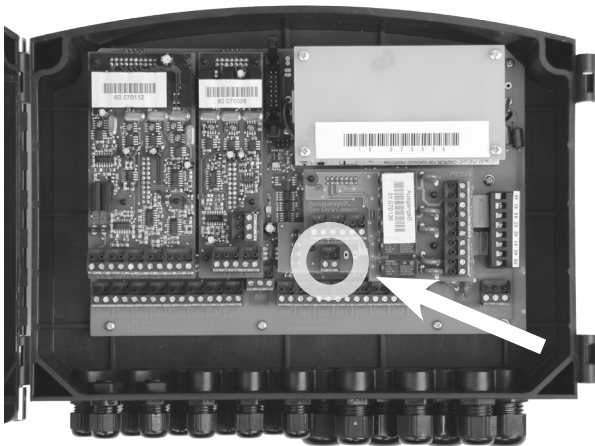

Fig. 4: RS 485 connections on the interface module board, partially obscured by the output module



CAUTION!

The data line must be locked at both sides with a 120 Ohm line resistance and must be supplied a firm potential using the two link plugs on the two jumpers on the circuit board of the display of all latest TOPAX versions.

Two link plugs/jumpers have to be connected to the TOPAX (the last one in the network) for the 120 ohm switch, Pull-up and Pull-down resistances. The resistances are not active when the system is delivered. The resistance of 120 ohms on the PC side is applied via the connector converter.

The jumper slots are located in the front of the housing on the display board, above the flat band-connection to the main board.

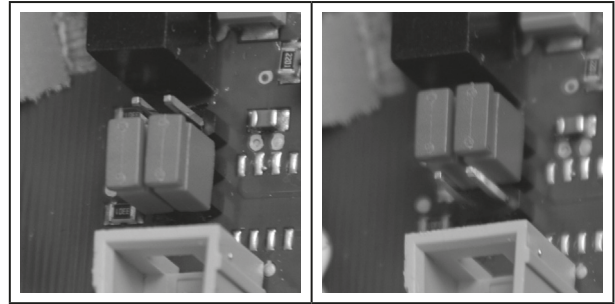

Fig. 5: Position and setting of the jumper to activate the RS 485 resistances on the last TOPAX in the network.

4.4.6 TopView software

For remote viewing on a PC the manufacturer offers the full version of the TopView display program and a freeware version with limited functionality. The "TopView mini" freeware version is free on the internet and can be downloaded from the manufacturer's website.

4.5 Power connections

The equipment may be installed and attached only by authorized and qualified electricians. Connections must be made according to the enclosed wiring diagrams.



ATTENTION!

Only work on electrical connections while the device is disconnected from the power supply.

Insert the cables in the various connections screwed on the bottom side of the housing. After the installation, tighten all cable connections so that the required protection class is provided.



Fig. 6: Cable connections for protected cable passage to the rear part of the housing.

For the connection to the power supply and to the actuators, TOPAX is equipped with special terminal clips.

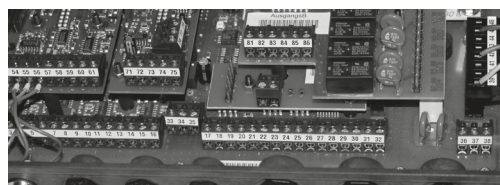

Fig. 7: The principle of the connecting terminal to the technical components.

For a better assembly these clamps are designed plug-ins, whereby the maximum cross section is 2.5 mm² for the power cord and 1.5 mm² for all other cable to the terminal clips.

Resistors deactivated (delivery status)	Resistors activated (last device in the network)
Jumper position: OFF	Jumper position: ON
The resistors are NOT active. The jumpers are set DOWN	The resistors are activated. The jumpers are set UP

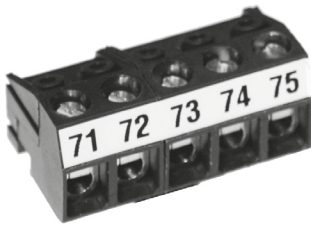

Fig.8: Individual connecting terminals, removable for installation, of the technical components.



ATTENTION!

When choosing the line material, for installation and electrical connection of the device, observe the regulations of VDE 0100 "Provisions for setting up electric power plants with nominal voltages below 1000 V" or the individual national rules.



ATTENTION!

The equipment is not suitable for the installation in explosive conditions!

4.5.1 Connection of the in- and outputs



NOTICE!

Terminal clips allocation depends on the software configuration of TOPAX. Terminal clips allocation depends on the delivered equipment.

The delivered equipment is listed in the protocol, which is attached to the device. Use this terminal plan to wire the device and to put it in operation.

4.5.2 Voltage supply

This instrument has no power switch and is immediately operative after the creation of the operating voltage. For this reason an external switch and/or protective switch is to be planned.

For the connection to the power supply at the main board, refer to the enclosed terminal plan (see "4.7 Terminal clips of the main board and the technical components" on page 11).



ATTENTION!

DO NOT let power be switched on via timer operation!

4.5.3 Sensor technology

Measuring cables may not be parallel when too close (less than 15 cm) to power switches and/or cables for power installation. Separate cable channels are to be used. Disturbing stray effects could otherwise falsify the measurement. Power supply and measuring lines at close proximity should only cross at a 90° angle.

The maximum permissible length of the measuring cables depends on the kind of the sensor. When performing very ohmic measurements (e.g. pH or REDOX measurements) the following is to be considered:

- Connections and patch cords must be clean and dry.
- The permissible bending radius of the cable must be respected.
- The quality of the holding wires must correspond to the defaults from the data sheet of the sensor.



IMPORTANT!

If possible a continuous cable is to be used from the sensor to the measuring entrance. An extension of the cable by plugs or terminal socket increases the risk of disturbances due to contamination, humidity or excessive transition resistances.

4.5.4 Connecting the actuators

When connecting your actuator the equipment must be switched off to prevent uncontrolled starting and malfunctioning.



WARNING!

If devices e.g. dosing pumps with inductive loads from a nominal current of 1 A are connected to a relay, the contacts in the relay may be bonded. Thus, the device will operate in an uncontrolled manner. This may also result in an overdosing of chemicals. To prevent the output relays from bonding if the load circuit shorts, they must be protected separately on the maximum relay switching current. For inductive loads, protective circuit must be applied to the relay contacts (spark suppression). The manufacturer recommends the use of the interference suppression module / spark suppression device (article 78614).

4.5.5 Replacing the batteries

The life of the batteries (Type VARTA, CR1/2 AA, 2 Volt, Lithium) provided with the internal instrument clock is approx. 5 – 10 years. When the batteries wear out causing a power shortage, a warning message will be displayed on the instrument. The battery is welded on the display circuit board. It must be replaced by a skilled technician.



Fig.9: Battery for internal clock, on the display circuit board.

4.6 TOPAX on the EASYPRO water sampling station

If the TOPAX is set up on an EASYPRO water sampling station, it controls the illumination of the LEDs. The LEDs of the sensors are controlled via the measured values. The LEDs illuminate green when the measured values lie within the set range. Leaving these ranges causes the LEDs to illuminate red.

The DIN contact must be activated in the control.

4.7 Terminal clips of the main board and the technical components

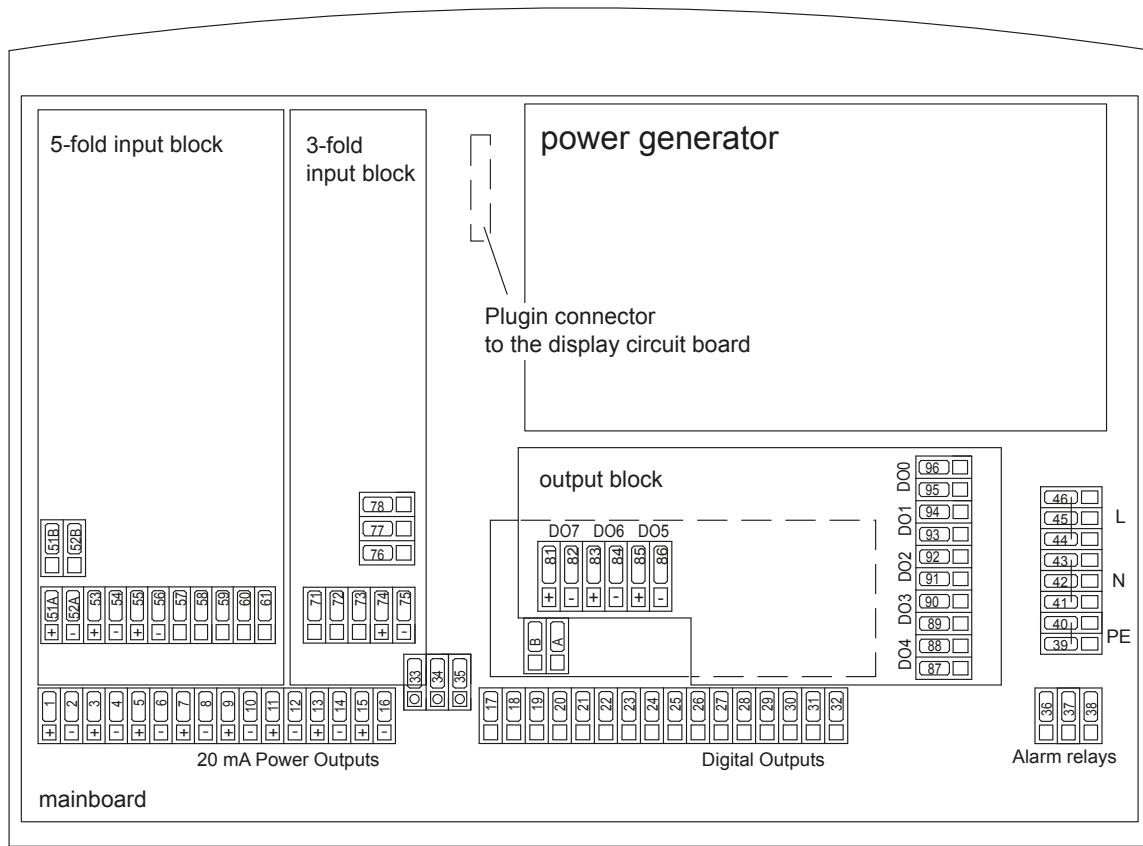

Fig.10: Rear part of the housing with the main board, the input module 5-fold, the input module 3-fold, the output module and the partly hidden PC interface.

4.7.1 Main board

Terminal	Function	
Analogue power outputs 0/4...20 mA (also see chapter 11)		
1	+	Measurement output 0/4...20 mA
2	-	Disinfection
3	+	Measurement output 0/4...20 mA
4	-	pH value
5	+	Measurement output 0/4...20 mA
6	-	Redox
7	+	Measurement output 0/4...20 mA
8	-	Temperature or programmed as controller output
9	+	Measurement output 0/4...20 mA
10	-	combined chlorine or programmed as controller output
11	+	Measurement output 0/4...20 mA
12	-	conductivity or programmed as controller output
13	+	Continuous control output 0/4...20 mA
14	-	programmed as controller output
15	+	Continuous control output 0/4...20 mA
16	-	programmed as controller output



ATTENTION!

The constant regulating outputs 0/40 ... 20 mA of the main board are also allocated automatically in the software configuration as per a fixed rank order of the terminals, in accordance with the allocation procedure for the output components.

Ranking of the outputs for automatic allocation:

1. Control output Disinfection
2. Control output pH value
3. Controller output for combined chlorine
4. Controller output for conductivity
5. Flocculation pump output

In the same way the clamps are assigned in a firm order.

- Terminals 15/16
- Terminals 13/14
- Terminals 11/12
- Terminals 9/10
- Terminals 7/8

The clip allocation is automatically displayed at the end of the configuration.

Terminal	Function		
Digital inputs			
17	potential free input	measuring water shortage *)	
18			
19	potential free input	filter cleaning *)	
20			
21	potential free input	low level alert Controller 1 **)	
22			
23	potential free input	level alarm Controller 1 **)	
24			
25	potential free input	low level alert Controller 2 **)	
26			
27	potential free input	level alarm Controller 2 **)	
28			
29	potential free input	activate night mode operation	
30			
31	potential free input	not used	
32			
*) normally ON or normally OFF			
**) normally ON or normally OFF or not active			
33	A	internal	interface for software updates
34	B	PC interface	
35	GND		
36		alarm relay as common	Opener
37		alarm	middle contact
38			Closer
39	PE	protective conductor	Voltage: 90 up to 264 V AC
40	PE		
41	N	neutral conductor	
42	N		
43	N		
44	L	phase	
45	L		
46	L		

4.7.2 Input module (5x)

Terminal		Function	Cable colour	Comment
51A	+	Disinfection (amperometric measuring cell type CS 120) Electrode mating copper/platinum or silver/platinum possible	CS 120 (Cu/Pt) Cu/ : blue (-) Pt/ : red (+) CS 120 (Ag/Pt) Ag/ : purple(-) Pt/ : red (+)	variant A and variant B can be only used as an alternative
52A	-			
51B	+	- total chlorine measuring cell (4...20 mA) - membrane covered cell Disinfection (0/4...20 mA) (20 mA input with 24 V DC sensor power)		
52B	-			
53	+	pH value		
54	-			
55	+	Redox		
56	-			
57		Temperature (polarity at wish)		
58				
59		potentiometer with positional feedback for servo motor (polarity of clips 59 and 61 at wish)		
60	Driver			
61				

4.7.3 Input module (3x)

Terminal	Function	Cable colour
71	Reference electrode (with integrated cable)	Disinfection (potentiostatic measuring cell) Reference electrode (Glass): black Counter electrode (Stainless steel): red Measuring electrode (gold): purple
72	Counter electrode Stainless steel	
73	Measuring electrode (gold)	
74	+	20 mA passive (no supply to the sensor) - conductivity measurement or disturbance variable
75	-	
76		Potentiometer with positional feedback for Servo motor. (polarity of clips 76 and 78 at wish)
77	Driver	
78		

4.7.4 Output module

Terminal	Output	
81	+	Electronic output (DO7) (Optocoupler) configurable
82	-	
83	+	Electronic output (DO6) (Optocoupler) configurable
84	-	
85		not available
86		
87		Relay output (DO 4) configurable
88		
89		Relay output (DO 3) configurable
90		
91		Relay output (DO 2) configurable
92		
93		Relay output (DO 1) configurable
94		
95		Relay output (DO 0) configurable
96		



ATTENTION!

The constant regulating outputs 0/40-20 mA of the output components are also allocated automatically in the software configuration as per a fixed rank order of the terminals, in accordance with the allocation procedure for the main board.

The outputs are allocated according to ranking:

1. Disinfection controller
2. Controller pH value
3. Controller combined chlorine
4. Controller conductivity
5. DIN contact
6. Eco-contact
7. Flocculation contact

Depending upon output type, chlorIDES selects the next free relay output or optocoupler. The clamps are assigned in a firm order: clamps 87/88 to 95/96 for relays, or 81/82 to 83/84 for optocouplers.

4.8 Input configuration

No.	Article name	Function	Terminal
1	Conductivity Transmitter and Measuring Cell 20/60 mS/cm	Conductivity	74 + 75
2	Diaphragm-covered Measuring Cell Type CD 4 MA	Chlorine dioxide	51B + 52B
3	Diaphragm-covered Sensor 4...20 mA Type CI 4.1 A 2	Free chlorine	51B + 52B
4	Disturbance variable 4-20 mA	Disturbance variable*	74 + 75
5	Measuring Cell for Total Chlorine	Total chlorine	51B + 52B
6	Measuring Electrode for Disinfection Measuring, Reference Electrode for Disinfection Measuring	Free chlorine	71 + 72 + 73
7	pH Single-Rod Measuring Cell PE110	pH	52 + 53
8	Redox Single-Rod Measuring Cell ME110	ORP	54 + 55
9	Reference Electrode for Potentiostat; SS Electrode for Potentiostat 1.4571; Gold Electrode for Potentiostat	Free chlorine	71 + 72 + 73
10	Residual Chlorine Measuring Cell CS120	Free chlorine	51A + 52A
11	Resistance Thermometer TE 110, PT100	Temperatur	56 + 57

Overview

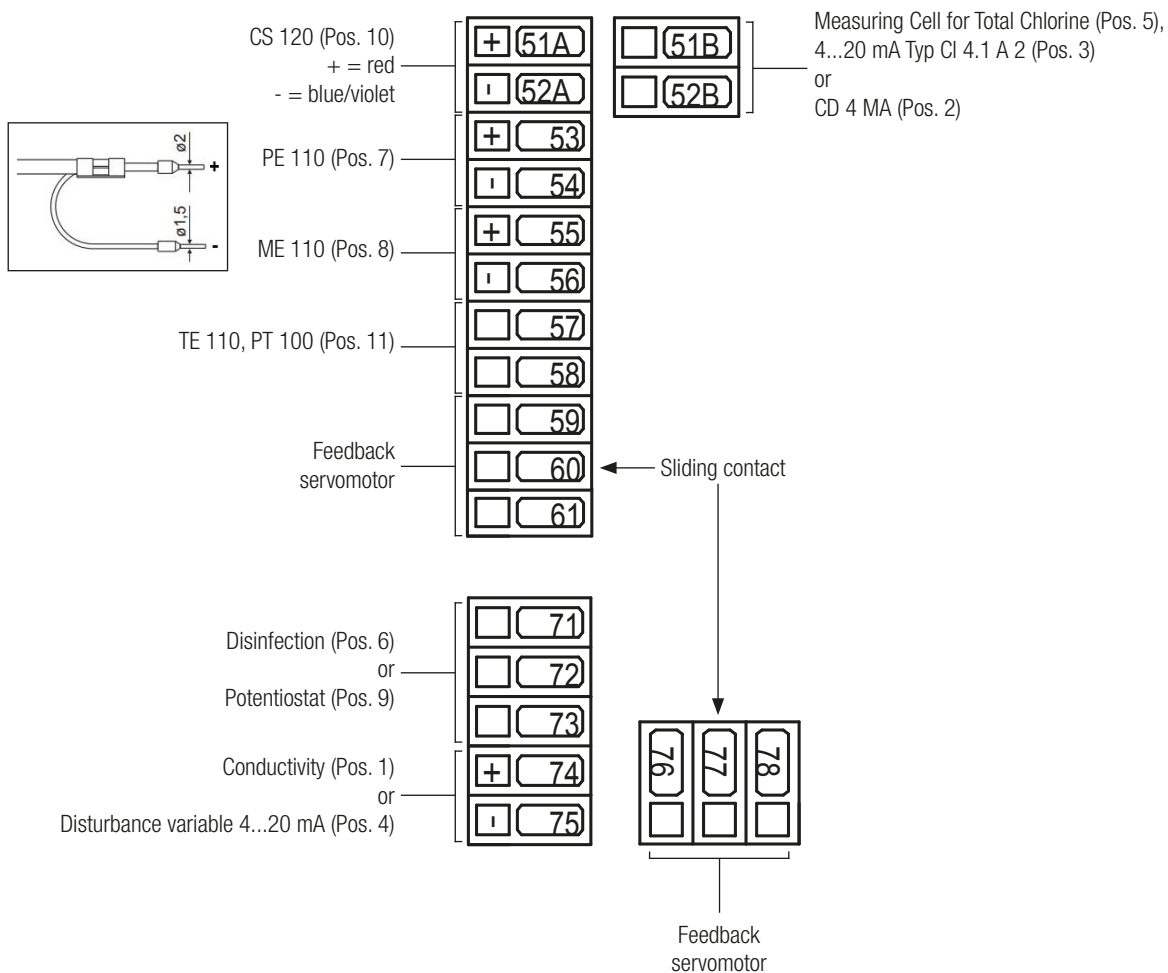

4.9 Output configuration

No.	Article name	Output	Configuration	Signal type	Terminal
1	C7700 20mA	Current output	Current output (20mA)	analogue	See TOPAX menu configuration 0.6.3
2	C7700 3-p-s	Relay (3 step)	3 point step with poti	digital	
3	EASYZON D/Da	Current output	Current output (20mA)	analogue	
4	MAGDOS DE, DX, LT, LDp, LD, LK, LP	Opto coupler output	Impulsefrequency (opto)	digital	
5	MAGDOS LA, LP, DX	Current output	Current output (20mA)	analogue	
6	MAGDOS LB bis 2018	Relay (with power relay*)	On/off	digital	
7	MAGDOS LDp, LD, LK, LP, LB ab 2018	Relay	On/off	digital	
8	MEMDOS DX, LA, LP	Current output	Current output (20mA)	analogue	
9	MEMDOS DX, LP	Opto coupler output	Impulsefrequency (opto)	digital	
10	MEMDOS E, LB	Relay (with motor protection*)	On/off	digital	
11	MEMDOS SMART LB, LD, LK, LP	Relaisausgang	On/off	digital	
12	MEMDOS SMART LD, LK, LP	Opto coupler output	Impulsefrequency (opto)	digital	
13	MEMDOS SMART LP	Current output	Current output (20mA)	analogue	
14	MIDIDOS E	Relay (with motor protection*)	On/off	digital	
15	MINIDOS A	Relay (with motor protection*)	On/off	digital	
16	Peristaltic pump	Relay (with motor protection*)	Impulselength (relais)	digital	
17	Technoline SC	Relay	Impulselength (relais), min. 300s	digital	
18	Technoline SC	Relay	On/off	digital	
19	Technomat PS	Relay	Impulselength (relais), min. 300s	digital	
20	Technomat PS	Relay	On/off	digital	
21	Technostar 2000 AT	Current output	Current output (20mA)	analogue	
22	Technostar ST-30	Current output	Current output (20mA)	analogue	

* accessories

Menu configuration 0.6.3



DANGER!

Open the housing of the TOPAX controller with disconnected power supply only! Secure the power supply to prevent it from being switched on again.

The assignment of the output terminals depends on the connected devices and their configuration. The required terminals are shown in the menu 0.6.3. The following steps will take you in that menu.

Precondition for action:

- The TOPAX controller has been successfully installed in accordance with section "4.5 Electrical installation" on page 9.
- The TOPAX controller is disconnected from the power supply.
- The housing of the TOPAX controller is closed.

Perform the following steps:

1. Establish the power supply of the TOPAX controller.
2. Wait until the device is booted.
3. Now press the following keys to get to the configuration menu:
 - „OK“,
 - „menu 2“,
 - „service“,
 - „OK“,
 - „edit“.
4. Now you are able to change the configuration of the different input and output terminals. Choose the configuration of the output terminals appropriate to the table above and confirm each entry with „next“ until you reached menu 0.5.
5. Press „save“ and confirm with „OK“. Now you can see the new configuration and the required terminals.
6. Press „next“ until you reached menu 0.6.3. Now you see the output terminals you have to connect your devices with. Note the numbers of the required terminals.
7. Press „next“ and confirm with „OK“.
8. Disconnect the power supply of the TOPAX controller, open the housing and connect your devices to the required terminals.
9. Check the correct control of your devices and make corrections if necessary.

The TOPAX controller can now control the connected devices.

4.9.1 Installation example with C 7700

Sensors connection

- Disinfection: Potentialstatic electrode
- pH value: Single-rod measuring cell
- Redox: Single-rod measuring cell

Controller connection

- Disinfection: C 7700 (servo motor with potentiometer)
- pH value: Solenoid-driven dosing pumps (Pulse frequency optocoupler)
- Other: Connection of PC interface RS 485

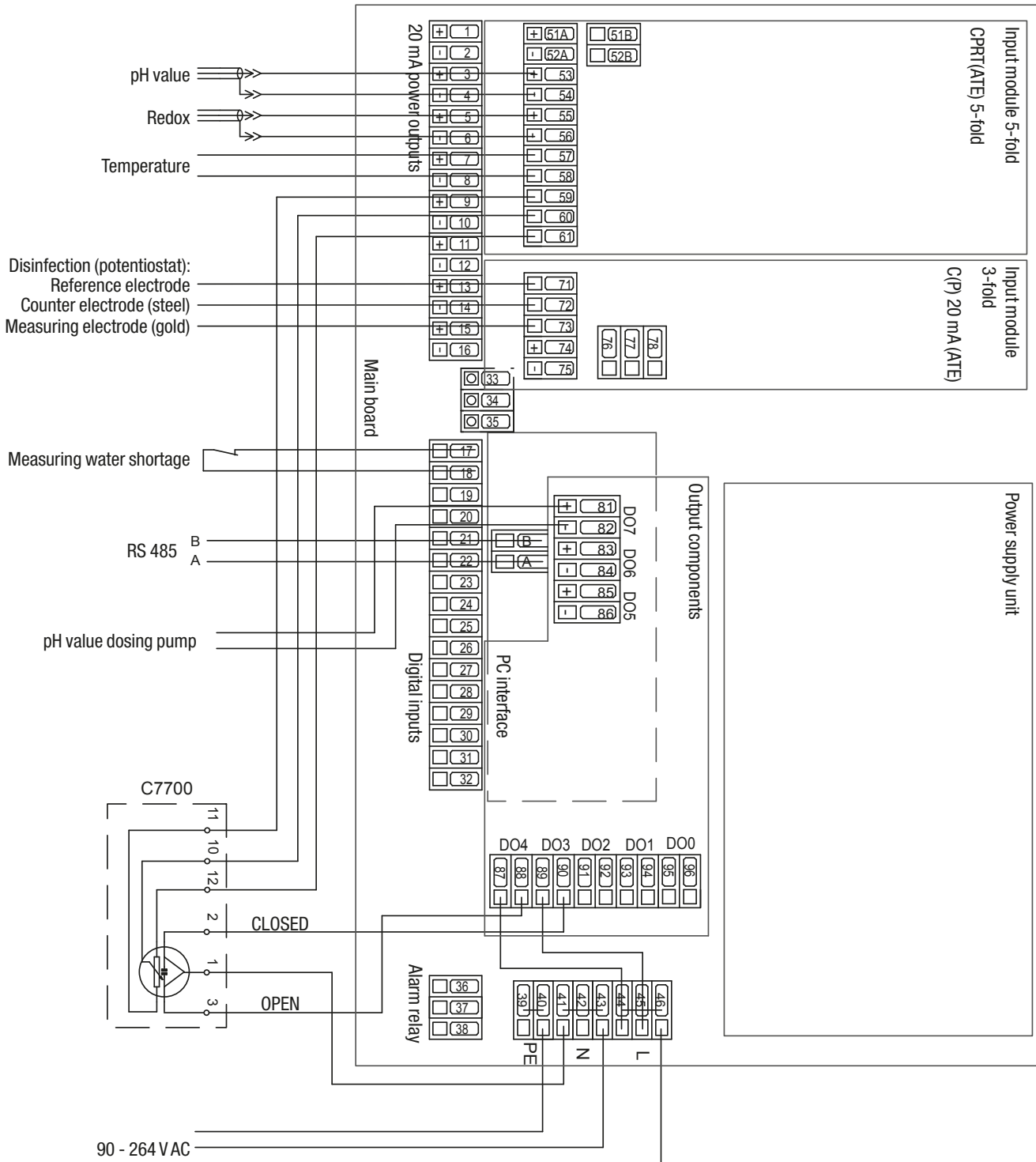

4.9.2 Installation example with peristaltic pumps

Controller connection

Disinfection: Peristaltic pump

pH value: Peristaltic pump

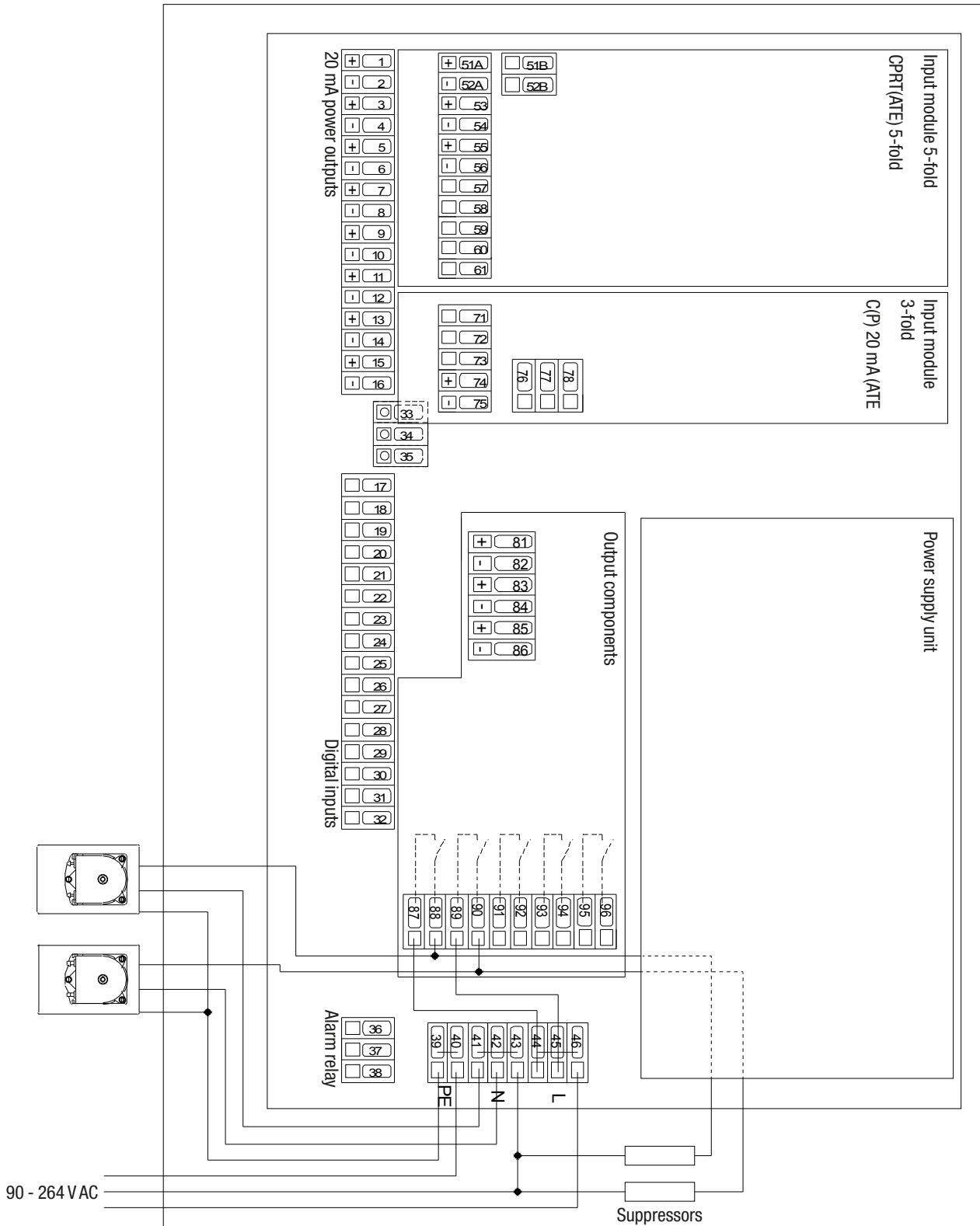

4.10 Operation and keyboard layout

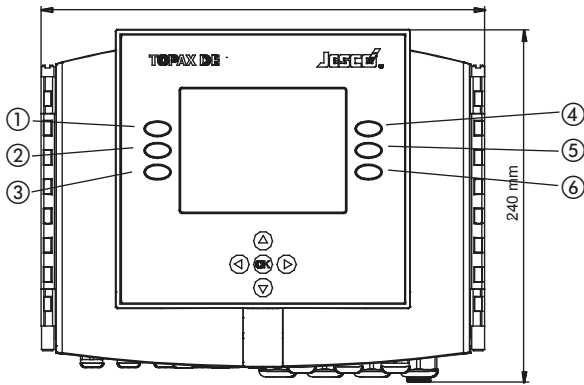

Fig.11: Housing of the TOPAX with operating panel.

Keys	Functions
Arrow key cross 	<ul style="list-style-type: none"> • Menu change in the "Service" menu • Change between individual numbers • Change numerical values, adjust parameters Press the key to change from one menu item to the other. Numeric values are entered and modified continuously.
"OK" key between the arrow keys	Accept and store inputs Saving is confirmed by a long beep noise.
Key ①: „ESC“	Exit the menu, one level back Terminate input without saving
Key ①: „ESC“ (press down for 5 seconds)	Return to the main menu
Keys ② - ⑥	The functions of the keys vary according to the menu and are displayed respectively.

If the device is not operated for approx. five minutes, the controller returns automatically to measuring mode. Changed parameters not confirmed with the "OK" key are not saved.

Exception: this time restriction does not apply during calibration and configuration.



NOTICE!

If no values or settings are to be changed, press "ESC" to exit the selected menus at any time. The controller uses the initial settings. Values and settings are confirmed and saved with the "OK" button. The exception to this rule are the "clock" and "timer" functions. They can be modified without confirmation.

General input rules:

- All values can only be changed within the permissible range.
- Some functions can be protected by a password against unauthorized access (see "12.1.23 Menus 5.9 and 5.10: Code und service password" on page 35).

4.11 First set-up and programming guidelines

After correct installation, switch on the power supply.

The TOPAX is programmed by the manufacturer based on customers' specs before shipment and is supplied along with a terminal connection diagram.



IMPORTANT!

All menus of TOPAX are shown a ID-number marked in the bottom line on the left display corner.

4.11.1 Backlight

The backlight of the chloriDES controller is dimmed automatically after 10 minutes and a blue LED under the arrow key cross is lit.

Once any key is pressed, the LED goes out and the backlight turns on again.

4.11.2 Choice of Language

After a short hardware test the during the initial start-up, the TOPAX displays the home page for configuration. This screen is shown until a language has been chosen by pressing the key ② (German), ③ (English), ⑤ (French) or ⑥ (further languages ">>").

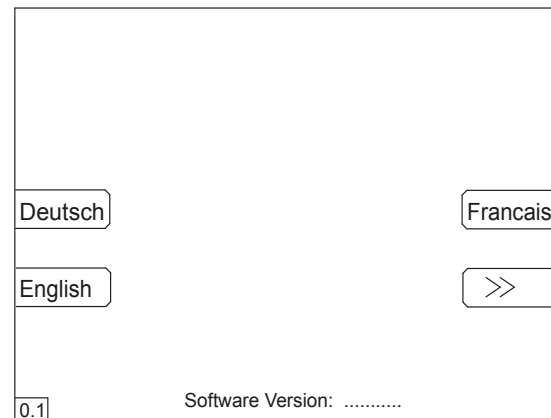

Fig.12: Home page for the configuration of language choice

4.11.3 Further languages - Memory card

Besides the fixed installed languages of German and English there is other language data for the TOPAX. These may be loaded from a memory card.

The memory card with the language data is inserted on the display board in the upper casing.

4.11.4 Help-Menu

The Help Menu is available as a point of help for many menu points. By pressing a random key the TOPAX returns to the previous menu again.

4.11.5 Menu 0.4.1: Input Disinfection

The disinfection connection will be pre-configured according to the order and cannot be changed.

The following options are possible:

- 2-electrodes measuring cell CS 120
- Potentiostat (PM)
- Encapsulated electrode
- Redox single-rod measuring cell
- Total chlorine measuring cell

The selected option is highlighted in grey.

4.11.6 Menu 0.4.2: Output Disinfection

With the arrow keys▲ and ▼ you can select between the options:

- Servomotor with potentiometer
- Servomotor without potentiometer
- Pulse frequency (Optocoupler)
- Pulse frequency (relay)
- Pulse length (relay)
- Continuous control output (20 mA)
- ON/OFF (relay)
- No controller function

The selected option is highlighted in grey. The entry is confirmed with the "OK", "Next" key or ►. The TOPAX then goes to the next menu.

The key "back" or ◀ leads to the previous menu.

4.11.7 Menu 0.4.3: pH output

With the arrow keys▲ and ▼ you can select between the options:

- Servomotor with potentiometer
- Servomotor without potentiometer
- Pulse frequency (Optocoupler)
- Pulse frequency (relay)
- Pulse length (relay)
- Continuous output (20 mA)
- 2-sides pulse frequency (relay) (Optocoupler)
- 2-sides pulse frequency (relay) (Relay)
- 2-sides pulse length (relay)
- ON/OFF (relay)
- No controller function

The selected option is highlighted in grey. The entry is confirmed with the "OK", "Next" key or ►. The TOPAX then goes to the next menu.

The key "back" or ◀ leads to the previous menu.

4.11.8 Menu 0.4.5: Input temperature

With the arrow keys▲ and ▼ you can select between the options:

- ON
- OFF

The selected option is highlighted in grey. The entry is confirmed with the "OK", "Next" key or ►. The TOPAX then goes to the next menu.

The key "back" or ◀ leads to the previous menu.

4.11.9 Menu 0.4.13: Input disturbance variable (optionally available)

With the arrow keys ▲ and ▼ you can select between the options:

- 0...20mA
- 4...20 mA
- OFF

The selected option is highlighted in grey.

To go back to the previous menu, press the key "back" or ◀.

4.11.10 Menu 0.5: Completing the configuration

The TOPAX moves immediately on to the configuration, at the latest after menu 0.4.13, in the finalising menu (menu 0.5) and shows the chosen configuration with all the previously chosen options in the total overview.

The configuration is saved with the "save" key and the finalising confirmation key "OK" and the TOPAX moves to the next menu 0.6.1.

The configuration starts from the beginning again with the key "back". The TOPAX then goes to menu 0.4.1.

4.11.11 Menu 0.6: Terminal connection clips

According to the chosen Options the TOPAX determines the relevant terminal connections and shows this in menus 0.6.1 to 0.6.4 (each by number of connections).

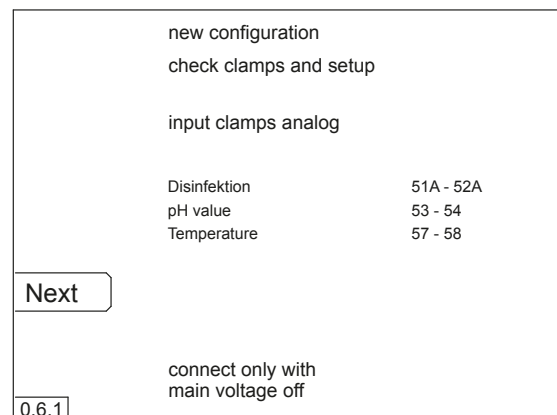

Fig. 13: Menu 0.6.1. - Example of a new configuration and the relevant terminal connection plan. A changed configuration will be displayed red.



NOTICE!

Make a note of the given connections on the pre-print in chapter "16 terminal connection diagram for own configurations" on page 39..

In order to move between the individual menus 0.6.1 to 0.6.4, press either the "next" or the "back" key, or the arrow keys ▲ and ▼.

To finalise the total configuration confirm the connection plan with the "OK" key. After confirming the configuration the TOPAX restarts and switches to the standard display.

More information about the TOPAX menu structure are given in chapter "12 Menu configuration and main settings" on page 29.

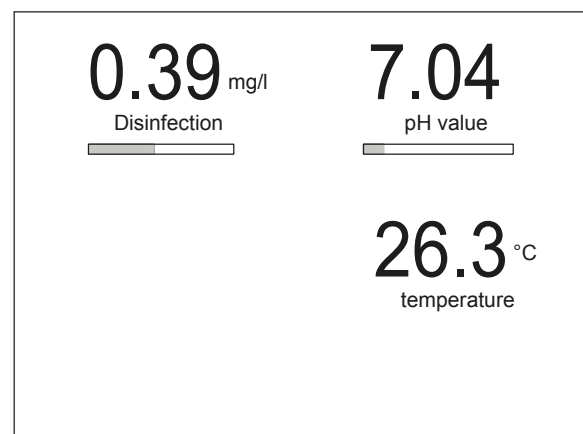

Fig. 14: Standard display with the measuring values.



NOTICE!

At start-up the controller outputs of your TOPAX will be function-less for approx 60 seconds. This time is required to stabilize the electrochemical sensors connected. During the start phase the status display indicates "Start in s" (seconds are shown). After this period of time, the TOPAX is ready for operation.



NOTICE!

In order to prevent unauthorised manipulation, the TOPAX has a password protection (see chapter "12.1.23 Menus 5.9 and 5.10: Code und service password" on page 35)

4.12 Next steps

After a successful configuration the next steps are:

- Connect the sensors and the actuators - if not already connected
- Calibrate the sensors to the measuring output (see chapter "5 Measuring values inputs" on page 19)
- Set up the set point of the measuring inputs (see chapter "12.1.4 Menu 1.1: Target values" on page 30)
- Set up the controller (see chapter "12.1.8 Menu 2.1: adjust controller" on page 32)
- Configuration of the regulating outputs (see chapter "7 Explanation of measuring values outputs" on page 24)



NOTICE!

The configuration of the in- and output can be recalled via the point "configuration" in the menu "service" whilst in operation (see chapter "12.1.13 Menu 5: Service" on page 34). Here the changes to the terminal plan are written in red figures.

5 Measuring values inputs

This section describes the chemical and physical correlations which are necessary to understand the behaviour of the measurement inputs.

The measurement inputs are processed for:

- Disinfection
- pH value
- Redox potential
- Temperature

A key element is the calibration of the sensors.



ATTENTION!

When set up the unit for the first time, care should be taken to perform individual calibration of each output immediately after connecting the sensors in the system. The TOPAX monitors all calibration processes based on reasonable parameters (zero point and transconductance). The readings are recorded. Non calibrated and "poorly" calibrated measurements inputs are shown in text form. "Poorly calibrated" measurements are shown in the main display in red.



ATTENTION!

Note that time delays are possible due to the run-in periods for the sensors.

The limits for "poorly calibrated" are:

Measurement	Limits
pH value transconductance	<40 mV/pH or > 61 mV/pH
pH zero point	< -40mV or > 40mV
slope rate Redox	< 0,85 mV / mV or > 1,2 mV / mV
slope rate chlorine at amperometric or potentiostatic measuring cell	< 3 µA / mg/l or > 100µA / mg/l
slope rate chlorine with encapsulated electrode (0..2.00 mg/l)	< 3mA / mg/l or > 13mA / mg/l
slope rate chlorine with encapsulated electrode (0...5.00/10.00 mg/l)	< 1mA / mg/l or > 5.2mg/l

The "poorly calibrated" display is only for reference and provides information on the calibration quality and the state of the electrochemical sensors.

Look for calibration faults and eliminate them. Replace the sensors as soon as possible, if necessary. You can use the sensors unchanged until replacement.

5.1 Measurement input Disinfection (amperometric measurement cells)

To measure the disinfection, amperometric measuring cells are used. These measuring cells are used to measure the concentration of the free hypochlorous acid ions if chlorine is used and/or the chlorine dioxide ions. The ion concentration at the work electrode results in an electric current flow which is analysed in the measurement amplifier.

Amperometric measuring cells can be classified according to the following criteria:

- open measuring cells,
- encapsulated electrodes.

If chlorine is used for disinfection, the dissociation of chlorine in the water depending on the pH value is to be observed.

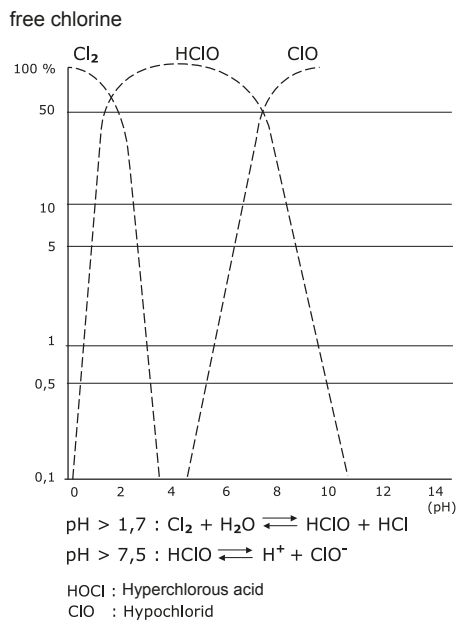

Fig.15: The dissociation curve shows the dependence on the pH value

For photometric measurements the pH value of the sample is buffered to approx. pH 6.5. As a result the measurement has a higher effective chlorine content than is actually in the process water. For high pH-values significant differences will therefore occur between the expected and actual disinfection if assessed by photometric analysis. The main display will show therefore two free chlorine values: The photometry value and the effective chlorine content ("eff. chlorine") to kill germs at the current pH value. For adjusting the display of effective chlorine see chapter "12.1.28 menu 5.17: Display" on page 36.

5.1.1 Technical data

Amperometric measurement of disinfection can be done using amperometric 2-electrode measurement cells, amperometric 3-electrode measurement cells with potentiostatic control or encapsulated electrodes (measurement signal 4...20 mA).

Following measuring ranges are possible:

Sensor type	Measuring range
Amperometric electrode (Excess chlorine detector with 2 electrodes type: CS120)	0...1.00 mg/l 0...2.00 mg/l 0...5.00 mg/l 0...10.00 mg/l
potentialstatic electrode type: PE (for free chlorine or chlorine dioxide)	0...1.00 mg/l or 0...2.00 mg/l

Encapsulated electrode type: Cl 4.1 A 2 (for free chlorine) type: CD 4 MA (for chlorine dioxide)	20 mA type; Set measuring range based on type of detector
Accuracy	± 1 % after calibration

5.1.2 Calibration

Calibration of amperometric, excess chlorine detector with 2 electrodes (CS120)

Before starting the calibration, the upper value of the measuring range of the sensor must be defined in the TOPAX (see chapter "12.1.17 Menu 5.1: Inputs" on page 35).

Then the input must be calibrated using a two-point calibration (see section "12.1.5 Menu 1.2: Calibration" on page 30):

The physical measurement (μA) measured on the measuring cell is shown on the display during calibration.

Reference value 1: Zero point calibration

To perform zero-point calibration, operate the detector in chlorine-free water or just stop the water flow through the instrument. The value of the physical quantity shown on the display (approx 5-10 μA) can be saved as soon as it stops changing. The device automatically changes to the next menu section.

Reference value 2: DPD

The sensor is operated with sample water. If the physical value on the display does not change anymore, the chlorine concentration in the sample water is determined by means of the DPD method. In order to avoid signal variations and consequent reading errors, water must be taken at the sensing element and the actual signal must be saved directly in the TOPAX upon taking of the water sample. The chlorine content in the sample water is determined by means of the DPD method. The measurement must be set in the controller and saved by pressing OK.

After storage the transconductance value of the chlorine sensor is shown. The typical resistivity value is approx. 25–35 μA (depending on water type) per mg/l of free chlorine. The plausibility of the transconductance measurement is monitored throughout the process.

1-point calibration is sufficient (reference value 2) for validation of the chlorine content after optimization.

Calibration of amperometric 3-electrode measurement cell with potentiostatic control (PE)

Before starting the calibration, the upper value of the measuring range of the sensor must be defined in the TOPAX (see chapter "12.1.17 Menu 5.1: Inputs" on page 35).

Then the input must be calibrated using a one-point calibration (see section "12.1.5 Menu 1.2: Calibration" on page 30):

Calibration method: DPD

The sensor is operated with sample water. A nearly stable physical value should be displayed. In order to avoid signal variations and consequent reading errors, water must be taken at the sensing element and the actual signal must be saved directly in the TOPAX upon taking of the water sample. The chlorine content in the sample water is determined by means of the DPD method. The measurement must be set in the controller and saved by pressing OK.

After storage the transconductance value of the chlorine sensor is shown. The typical resistivity value is approx. 35 μA (depending on water type) per mg/l of free chlorine. The typical slope value is approx. 10 μA per mg/l of free chlorine dioxide.

The plausibility of the transconductance measurement is monitored throughout the process.



ATTENTION!

When operating in a heating water system, electro-chemical processes at the measuring electrode may cause a shift of the zero point by means of electro-chemical processes. In this case, a two point calibration is required. The zero point must be adjusted with chlorine-free heating water. Thereafter, the slope of the measuring cell can be adjusted by using the DPD method.



NOTICE!

When measuring the free chlorine with a potentiostat it is possible to perform a compensation of the pH-value and the temperature. This is done by connecting a pH-electrode and a temperature sensor to TOPAX (see chapter "12.1.17 Menu 5.1: Inputs" on page 35)

Calibration of encapsulated electrode

Before starting the calibration, the upper value of the measuring range of the sensor must be defined in the TOPAX (see chapter "12.1.17 Menu 5.1: Inputs" on page 35).

Then the input must be calibrated using a one-point or two-point calibration (see section "12.1.5 Menu 1.2: Calibration" on page 30):



ATTENTION!

When measuring free chlorine by means of a fully encapsulated electrode, make sure to connect both terminal clips 51 B and 52 B. These clips are respectively used to feed the 20 mA signal of the electrode into the controller and to supply 24 VDC operating power to the sensing electronics of the electrode.

5.1.3 Zero-point calibration (in case of 2-point calibration)

Zero point calibration of the sensing electrode is normally not a must-requirement, as tuning of the 4 ... 20 mA output signal of the electrode is done on input 4 ... 20 mA (4 mA corresponds to 0,00 mg/l).

However, a zero-point calibration may be still required due to the tolerances of the sensing electronics of the electrode. For this reason the zero-point must be set upon first setup of the instrument.

Calibration method: DPD

The sensor is operated with sample water. A nearly stable physical value should be displayed. In order to avoid signal variations and consequent reading errors, water must be taken at the sensing element and the actual signal must be saved directly in the TOPAX upon taking of the water sample. The chlorine content in the sample water is determined by means of the DPD method. The measurement must be set in the controller and saved by pressing OK.

After storage the transconductance value of the chlorine sensor is shown.

The plausibility of the transconductance measurement is monitored throughout the process.



IMPORTANT!

The signal from the excess-chlorine sensing detector is converted by the electrode into an impressed current pulse of 4...20 mA. Whenever your TOPAX features a lower value than 3.5 mA, an alert message is displayed „total chlorine sensor failure“, the alarm relay is switched.

5.2 pH value measurement input

5.2.1 Technical data

Power output	Values
Input	Voltage signal from a pH single-rod measuring cell
Input resistance	10 ⁹ ohms
Measuring accuracy	1 % (after calibration)

The ph single-rod measuring cell supplies a voltage which is proportional to the pH value. This voltage is defined by the Nernst voltage. The Nernst voltage is the change in voltage per pH unit. It depends on the temperature of the medium to be measured (see corresponding technical literature or German Standard DIN 19261).

The following table shows the temperature dependence of the Nernst voltage:

t (°C)	U (mV)	t (°C)	U (mV)	t (°C)	U (mV)
0	54.20	35	61.14	70	68.08
5	55.19	40	62.13	75	69.08
10	56.18	45	63.12	80	70.07
15	57.17	50	64.12	85	71.06
20	58.16	55	65.11	90	72.05
25	59.16	60	66.10	95	73.04
30	60.15	65	67.09	100	74.04

The Nernst voltage is measured between the pH glass electrode and a reference electrode. These two electrodes are physically integrated in a pH single-rod measuring cell.

5.2.2 Adjustment

Calibration of the single-rod measuring cell may be performed via a "2-point calibration" with 2 buffer solutions or a "single point calibration" with subsequent input of the single-rod measuring cell transconductance. The mandatory conditions for using „1-point calibration“, is that the resistivity of the sensing electrode must be previously measured in a lab.

The actual voltage of the electrode and the design value of buffer solution are displayed on the TOPAX during calibration so that the electrode can be actually graded while performing the calibration process. This allows the rating of the single-rod measuring cell to be determined during calibration, assuming fresh buffer solutions.

The response time for a new single-rod measuring chain is a few seconds and is set when the physical reading becomes stable. For older single-rod measuring cells the response time may be longer.

The single-rod measuring cell is directly connected to the input terminals of the circuit board of the input module 5-fold (see section "4.4 Technical components" on page 8).

2-point calibration

The physical measuring value (mV) on the electrode is displayed in the menu (see chapter "12.1.5 Menu 1.2: Calibration" on page 30) along with the design measuring value that should be ideally assessed for the Ph.

Buffer 1: Zero point calibration

Submerge the pH combination electrode in a buffer solution which is equivalent or close to the zero point of the electrode. The ideal electrode zero-point (0 mV) is at a pH of 7.00. However, the real zero-point shows minimum variations as against this minimum value. For zero-point cali-

bration a buffer solution of pH 6.80 is available. When soaking the Ph-electrode in this solution, a voltage of 12 mV should be displayed on the TOPAX. The physical value actually measured is, however, always different from the theoretical one.

When the physical value on the display becomes stable you can save the reference value with "OK".



IMPORTANT!

Should the actual measured voltage strongly differ from the design zero-point of the electrode, it means there is a zero-point drift of the electrode. This should not exceed the specifications of the DIN Standards 19265. In the event of zero-point drift exceeding ± 40 mV, TOPAX warns you about possible bad probe calibration.

Buffer 2: Transconductance calibration

Clean the single-rod measuring cell before calibrating the transconductance (flush out with distilled water).



ATTENTION!

Avoid rubbing off glass electrodes as this will produce a static charge on the electrode. This would result in faulty readings.

For transconductance calibration a buffer solution must be used which differs at least 2 pH units from the zero point. For transconductance calibration the manufacturer offers a buffer solution of pH 9.27. Should you use a different buffer solution for calibration of the resistivity, you first need to set TOPAX to the pH of your other solution. When soaking the Ph-electrode in this buffer solution (Ph = 9.27), a voltage of -134 mV should be displayed on the TOPAX. The physical value actually measured however always differs from the theoretical one. Confirm presetting by pressing "OK".

The transconductance value of the single-rod measuring cell is then displayed. In accordance with DIN 19265 the transconductance of the single-rod measuring cell should lie between 52 and 59 mV per pH-value.

Zero-point stability and accuracy of the measured resistivity are consistently monitored.



IMPORTANT!

If the slope value differs considerably from these values, check the combination electrode or the connecting cable and the plug connectors. If the "zero-point" and "transconductance" values of the single-rod measuring cell exceed the tolerances, the system notifies the operator with a warning message. The measuring cell should then be replaced as soon as possible.

Theoretical voltage value of different buffer solutions at 20°C:

buffer solution	voltage value
3.06	229.15 mV
4.65	136.68 mV
6.80	11.63 mV
9.27	-132.02 mV



IMPORTANT!

Store buffer solutions in a cool and dark place. Consider their useful life. Make sure that the buffer solution is not contaminated. For this reason single-rod measuring cells should not be moved directly from one buffer solution to another.

1-point calibration

Single-point calibration may also be used for pH calibration with a single-rod measuring cell (see section "12.1.5 Menu 1.2: Calibration" on page 30).

Submerge the pH combination electrode in a buffer solution which is equivalent or close to the zero point of the electrode. The ideal electrode zero-point (0 mV) is at a pH of 7.00. However, the real zero-point shows minimum variations as against this minimum value. For the zero point calibration a buffer solution of pH 6.80 (TOPAX default setting) is available from the manufacturer.

When soaking the Ph-electrode in this solution, a voltage of 12 mV should be displayed on the TOPAX. The measured physical value however always differs from the theoretical one.

When the physical value on the display becomes stable you can save the reference value with "OK".

Now enter the transconductance of the single-rod measuring cell.



IMPORTANT!

If the actual measured voltage differs significantly from the theoretical zero-point of the measuring cell, there is a zero-point drift on the measuring cell. Zero-point drift should not exceed the specifications of the DIN 19265 (± 40 mV).

5.2.3 Offset compensation

In accordance with DIN 19643, the pH value should be checked via an electro-metric pH value measurement.

External influences can cause the pH value of the electro-metric measurement, measured by hand with the photometer, to deviate by a constant value. The menu "offset alignment" offers the possibility to eliminate the difference.



ATTENTION!

The offset value is set to "0" after each new calibration.

5.3 Measurement output Redox potential

The REDOX potential can be used to control the disinfection performance.

5.3.1 Technical data

Power output	Values
Input	Voltage signal of a Redox single-rod measuring cell (0-1000 mV)
Input resistance	10 ⁹ Ohm.
Measuring accuracy	1 % (after calibration)

The Redox potential is measured with the help of the Redox single-rod measuring cell. It measures the voltage which exists in the water due to oxidizing and reducing ions.

5.3.2 Calibration

Calibrate the single-rod measuring cell during startup. For calibration of the Redox single-rod measuring cell only one reference value must be set. The physical measurement on the measuring cell (mV) is shown on the display during calibration.

For calibration a buffer solution is required in order to measure a defined voltage in connection with the REDOX combination electrode. (given value: 468 mV). This value can be changed when using other buffer solutions or when using single-rod measuring cells with other electrolytes. To change, use the buttons in the operating cross. The actual voltage measured is shown on the display during calibration. This reading differs slightly from the fixed buffer solution value. The deviation should not exceed 10% approximately.

The plausibility of the transconductance measurement is monitored throughout the process.

After a reaction time (approx. 1 minute) the physical value does not change anymore.

The reference value can be now adjusted and saved by pressing "OK".



IMPORTANT!

With older single-rod measuring cells the response time can increase or the reading differ significantly from the buffer solution value. This indicates that the single-rod measuring cell must be checked and replaced if necessary.

The single-rod measuring cell is directly connected to the input terminals of the circuit board of the input module 5-fold (see section "4.4 Technical components" on page 8).



IMPORTANT!

The measuring signal of the REDOX combination electrode can be also configured for controlling the disinfection.

5.4 Temperature measurement input

5.4.1 Technical data

Power output	Values
Sensor	Pt 100
Measuring range:	-50°C – +150°C
Measuring accuracy	1 %

Do not use other than a two-wire "Pt 100" as sensor.

5.4.2 Adjustment

The zero point of the measuring input is set in the factory. This measuring input can be adjusted with the temperature of the measuring water of the TOPAX (see chapter "12.1.5 Menu 1.2: Calibration" on page 30).

For this purpose, measure the temperature of the sample water with a reference thermometer and set the measured value as reference in the TOPAX.

6 Explanation of digital signal inputs

6.4.1 General

It is possible to interrupt the control process and to activate an alarm by external digital signals. These inputs can be configured in the menu as "normally close" or "normally open" and the level inputs must be additionally deactivated.

6.1 Start-up delay

The digital signal inputs causes alarm and/or auxiliary functions, which interferes with the normal functions of the automatic controller.

If a digital signal input is operated and if the appropriate function is implemented, this has mostly effects on the quality of the measurement and the regulation will be set to "0%". After that the automatic work of the automatic controller is again configured; if a start-up lag time occurs, the sensors reset themselves to the automatic measuring procedure.



ATTENTION!

The start-up delay is activated:

- after a "remote switchoff" (measuring water shortage)
- after the calibration of a measuring input
- when switching on a supply voltage

6.2 Deactivation of the controller function with alarm signaling in the case of lack of sample water

6.2.1 measuring water shortage

By an external flow contact the automatic controller functions activates. If the function "shortage of measuring water" is active and it arises a shortage of measuring water, all automatic controller outputs are set to "0 %", thus switching alarm relays; the announcement "shortage of measuring water" appears in the display.

6.3 Low level alert, alarm and warning "level dosing pump"

By an external contact e.g. of the level switches of an intake, the connection between the clamps 21 and 22 (intake dosing pump free chlorine) and/or. 25 and 26 (intake dosing pump pH value) can be opened and/or closed. The announcement "Disinfection low level alert" and/or "pH value low level alert" appear in on the display and the alarm relay switches. The chemicals must be refilled.

No chemicals refilled can be opened and/or closed after a further contact of the intake connection between the clamps 23 and 24 (intake dosing pump free chlorine) and/or 27 and 28 (intake dosing pump pH value). The announcement "Disinfection level Alarm" and/or "pH value level Alarm" appears on the display and the alarm relay switches; at the same time the automatic controller output line of the respective input is set to 0.



ATTENTION!

If the level inputs in the menu "Service digital inputs" are activated, the level switches must be connected to the terminals respectively. If no level switch is attached, the inputs are to be deactivated.

7 Explanation of measuring values outputs

7.1 General

The TOPAX can be used to regulate the disinfection and the pH value.

During configuration of the TOPAX, an output type has been assigned to each controller.

Possible are:

- Servo motor with potentiometer (with feedback)
- Servo motor without potentiometer (without feedback)
- Pulse frequency (electronic / optocoupler)
- Pulse frequency (relay)
- Continuous (current) output 0/4 ... 20 mA
- ON/OFF (relay)

7.2 Output types

The regulating outputs can be calibrated in several aspects (see chapter "12.1.18 Menu 5.2: Outputs" on page 35):

7.2.1 ON/OFF (relay)

Relay output - if the adjusted value are excessive the relay switches, a hysteresis is adjustable.

7.2.2 Pulse length

10-3600 seconds cycle time, relay output (e.g. for solenoid valves).

Depending on the control deviation and the defined control parameters, the relay pulls in or drops out for the set cycle duration. If the cycle lasts 30 seconds and the controller output power is 40% the relay applies for example for 12 seconds, followed by 18 seconds of non-application.

7.2.3 Pulse frequency

10-350 pulses per minute as a adjustable maximum

The pulse frequency depends on the control deviation and the set control parameters, e.g. for a controller output power of $Y = 25\%$ and a pulse frequency of 100 pulses/minute, the controller sends 25 pulses/minute.

Observe the maximum stroke frequency of the connected pump.

7.2.4 Electronic output (optocoupler output)

Pulse frequency output for controlling solenoid-driven dosing pumps or motor-driven pumps (e.g. MAGDOS or MEMDOS pumps) with intelligent electronic control unit. Ensure the correct polarity.

7.2.5 Relay output

Pulse frequency output, pulse length output, 3-point-step output (for servo motors) or "ON/OFF" for the control of magnet dosing pumps, hose pumps or single solenoid valves.

3-point-step output for servo motors

Relay output (e.g. for chlorine control valve C7700).

A acknowledging potentiometer can not be connected with servo motors with position feedback (1-10 kOhm). The acknowledging potentiometer is to be adjusted. For calibration the servomotor is started first. The voltage, which lines up over the acknowledging potentiometer, is indicated in the position of the potentiometers (voltage display between 0 and 3 V). After the stop position has been reached, the servomotor is stopped automatically. The alignment is accomplished and is to be stored in the TOPAX.

The switching hysteresis can be set from 1-20%.



ATTENTION!

If during ongoing operation, due to faults or the like, the end position and/or the zero point is not reached after approx. 10 minutes, the "Servo motor alarm" error message will be displayed. The error tolerance is coupled to the switching hysteresis of the "3-point step" control type. .

A servo actuator without feedback can also be operated. This is to be selected with the configuration.

If no positional feedback is available, measure and adjust the motor life (see chapter "12.1.13 Menu 5: Service" on page 34).



ATTENTION!

Entering a wrong motor life may prevent accurate controller functioning. In this case you would receive no warranty coverage by the manufacturer. The motor cycle time is set by the factory at 120 seconds which corresponds to the cycle time of the motor of the chlorine gas valve C7700.

7.2.6 Continuous control output (20 mA current output)

For automatic controllers a continuous control output of 0/4 ... 20 mA can be configured for the control of continuous actuators.

The current varies between 0 and 20 mA depending on the deviation. Max. load: 500 Ohm

The 20 mA current output for free chlorine is switched on for every configuration.

You can choose between:

- 0...20 mA
- 4...20 mA
- 20...0 mA and
- 20...4 mA

7.3 Output restriction

The maximum output of each controller can be restricted. To do this, enter the maximum percentage value the actuator can reach.

Example: If a value of "80%" is entered, the controller moves the actuator up to a maximum of 80%. The control algorithm however is still calculated to "100%". Note that the controller parameters are selected accordingly.

The lowest maximum setting is "50 %".

This limit is useful if for example an oversized dosing pump has been fitted. This will ensure precise control.

7.4 Actuator

Components such as pumps and solenoid valves, which are controlled by the TOPAX, are called actuators.

Depending on the final control element used, different control functions can be set. Possible options are a continuous output with impressed current (0/4 ... 20 mA), or control outputs (with pulse frequency). The latter can be controlled as electronic (optocoupler) or relay outputs.

8 Controller explanation

8.1 Definitions

Term	Definition
actual value (X)	The actual value of X of the measurement for the respective sensor is constantly indicated.
Setpoint (W)	Setpoint W of a control system defines the level at which the controller should settle the process and keep it constant.
Control deviation (X-W)	Control deviation X-W occurs if the actual value X of the measurand differs from setpoint W. Control variable Y results from the control deviation and the control parameters set.
Control variable Y	Control variable Y of a control system defines the value which the controller transmits to the final control element depending on the parameters set and control deviation X-W (between 0 % and 100 %).

8.2 Proportional controller (P controller)

8.2.1 Proportional range Xp

(proportional effect or amplification of the controller)

The proportional range Xp (p-range) of a proportional controller indicates the amount by which the measurand X must deviate from the setpoint W, so that the control variable Y = 100%. If the control deviation is less, the control variable is reduced proportionally.

Control variable Y of a P-controller is affected proportionally only by the control deviation (X - W).

The P-range is indicated in "%" and always refers to the measuring range final value.

The proportional range is therefore an indirect measurement of the control amplification K_r :

$$K_r = 100\% / Xp\%$$

For an Xp range of 50% the control amplification is accordingly:

$$100 / 50 = 2 \rightarrow \text{controller amplification } K_r = 2$$

Xp = 50% means that the control variable Y changes 100% if the actual value deviates by 50% from the setpoint (related to the measuring range final value).

8.3 Proportional-integral-derivative controller (PI, PID controller)

8.3.1 Reset time Tn

(integral effect of PI controller)

The integral time of a PI or PID controller is called the reset time Tn. The integral time is the time required by the control variable Y with a constant nominal/actual deviation to achieve the same change in output signal as produced immediately by the P proportion immediately after the change in the nominal/actual deviation.

8.3.2 Example of proportional range and reset time

$X_p = 50\%$ (amplification = 2)

$T_n = 3\text{min}$

(sudden change of the actual value by 15%)

After a sudden deviation of the actual value from the setpoint of around 15% (X-W), the control variable Y changes by the same rate as the control amplification, or twice as much as the X_p value, i.e. by 30%.

Because of the integral behaviour, the manipulated variable continues to increase as long as the X-to-W deviation remains present and after a time $T_n = 3$ minutes reaches once again 30 % of correction variable increase.

Control variable	Setpoint
Measuring range for free chlorine	1.00 mg/l
X (actual value)	0.15 mg/l
W (Setpoint)	0.30 mg/l
X - W	15 %
X_p (P-range)	50 %
T_n	3 minutes
Y (immediate power output of the controller)	30% through X_p
Y (output power of the automatic controller after 3 minutes)	60% through T_n

8.3.3 Derivative time T_v

(differential action of PID controller)

By a differential function a correction factor is entered in the controlled system when the controlled variable begins to differ from the default value. The control variable depends on the speed at which the nominal/actual deviation takes place (i.e. not the actual deviation). The duration of the correction is determined by the derivative time T_v . If the control variable does not change, i.e. the speed of change is "0", the correction factor and the time constants T_v caused by the differential proportion drop to "0" (even if the actual value consistently deviates from the setpoint). The fact that the regulation leads the actual value to match with the default one is caused mainly by the integrals portion of the automatic controller. The differential proportion often improves the controller result because it acts against the trend to deviate.

8.4 Calculation of setable values

In order for the controller to keep actual values of free chlorine and Ph close to the setpoints within tight limits, e.g. for bathing, the controller must be adjusted to the controlled system. This is achieved via the control parameters X_p for the proportional area, T_n for the reset time of the integral range and the derivative time T_v for the differential range.

These settings can be determined by recording the step response of the controlled system. To do this the actuator must be changed suddenly by hand from "CLOSED" (0 %) to "OPEN" (100 %) or for example from 30% to 50%.

The following formula can be used for calculating reference values:

$$X_p \sim 0.83 \cdot \Delta X / \Delta t \cdot T_u$$

$$T_n \sim 3,3 \cdot T_u$$

Variable	Description
Y_h	Setting range (e.g. valve fully open or 100% dosing pump supply)
X_{max}	maximum value of the controller variable at 100 % dosing rate
$\Delta X / \Delta t$	Gradient of the measured curve (see Fig.17)
t_o	Time of control variable Y change
T_u	lag time (s)
V_{max}	maximum increase rate of the measured variable
V_{max}	$X_{max} / T_g = \Delta X / \Delta t$

In order to meter chlorine gas, you need accounting for the speed of the chlorine gas valve. The value of X_p is computed for a drive speed from 0 % through 100 % in 60 seconds. A slower operation would show the same trend as a bigger proportional range X_p . In order to adjust this, the X_p value must be first reduced at slower operation and vice versa.

The following formula can be used:

$$X_{p\text{ new}} = X_p \cdot 60 \text{ sec} / T_y$$

T_y = Motor regulation time

As these are approximate values, changing the X_p value may after a certain time improve the control variable. If the control responds too slowly or too fast, a smaller X_p and a smaller T_n would result in a faster control behaviour and a larger X_p and/or T_n would result in slower behaviour.

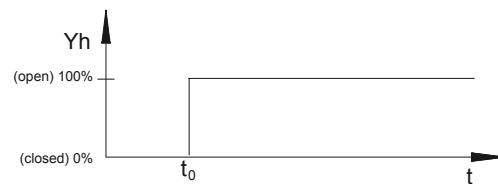

Fig.16: State of the control variable, e.g. opening of a valve or dosing rate of a pump.

Here below, a diagram shows for the controlled variable X over the time t:

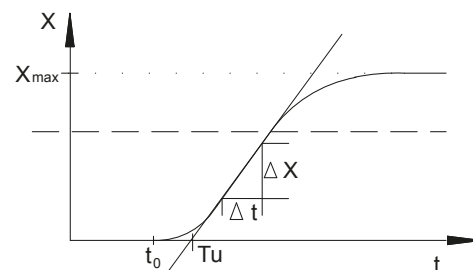

Fig.17: Step response of a controller to a change in control variable Y.(X = actual value; e.g. free chlorine or pH value)

The control parameters can be automatically entered in the TOPAX in the respective items (see chapter "12.1.13 Menu 5: Service" on page 34).

8.5 Controller parameters

For Disinfection, pH value, bonded chlorine and conductivity inputs the following settings may be programmed:

Con-troller	Xp value	Tn value	pH value
P	1 - 500 %	-	
PI	1 - 500 %	1 - 200 min	
PD	1 - 500 %		1 - 1200 s
PID	1 - 500 %	1 - 200 min	1 - 1200 s

The following control parameters are set by the manufacturer before shipment:

Controller	Xp	Tn	Tv
Disinfection controller	35 %	15 min	OFF
Controller pH value	10 %	15 min	OFF

8.6 Control direction

The control direction can be set for each controller. Possible options:

- increase value (display "up" arrow)
- decrease value (display "down" arrow)
- 2-side regulation (only free chlorine and pH value)

The connection terminals are also marked with an arrow.

8.7 Basic load dosing

Basic load dosing can be configured outside of the control range. This dosing takes place even if the PID automatic controller output is 0%. If a basic load is configured, this value is shown in blue on the display screen in the Y display. The Y display for automatic control is shown in green. In the status display, this condition is indicated by a "+" after the Y display. Note that this basic load is always effective and that a certain percentage of the actuator is always open irrespective of the control even though the controller does not require dosing. The basic load can be adjusted separately for each output up to a maximum of 20% of the control range.

8.8 Manual mode

Controllers can be manually adjusted.

If a controller is manually operated, this will be indicated by a large "M" behind the "Y" in the status displays and the Y display on the screen will be shown blue. Manual operation is also indicated in the bottom row.

In the manual setting menu the control output can be adjusted directly to any value between 0% and 100% and saved.



ATTENTION!

Manual operation is not reset automatically.

9 Alarms

9.1 Measurement alarms

For each measuring input a minimum and a maximum alarm can be set. In the case of a value falling above or below this value, the alarm is shown and an alarm relay as common alarm triggers. The alarm settings of the relay and the controller for this measuring input can be analysed separately. The time delay of the alarm is adjustable (delay).

9.2 Safety cutout (Y alarm)

TOPAX is equipped with a safety disconnect. If, due to an unforeseeable event, a sensor fault etc. the controller output power exceeds 95% for a programmable period, an alarm is displayed for this controller and the controller output is set to 0%. This function is activated by default. The time is adjustable.

An adjusted basic load is also switched off in the event of a safety cutout.

All alarms are displayed in clear text form on the screen. The alarm relay is activated and the measured value, which caused the alarm, is shown in red.



ATTENTION!

The alarms are represented in red on the display. After clearing, acknowledge the alarms by pressing the OK key twice.

(see also chapter "15 Troubleshooting and diagnostics" on page 38).

10 Analogue power outputs 0/4 ... 20 mA for remote displays

For the remote indication of the measured values, TOPAX has a similar output for each measured value input 0/4 ... 20 mA.

The settings 0 ... 20 mA or 4 ... 20 mA see chapter "12.1.26 menu 5.15: Recorder outputs" on page 35. The adjustment of the outputs to external devices is made however in menu 2 (see chapter "12.1.11 Menu 2.3: Recorder (analogue outputs 0/4 ... 20 mA)" on page 33). A measurement can be assigned to the minimum and maximum values.

In order to check the outputs and for adjusting them to the attached instruments and devices, you submit the 20 mA outputs to a test signal (see chapter "12.1.26 menu 5.15: Recorder outputs" on page 35).

The signal can assume any value between 0 and 20 mA. This can be achieved individually for the configured controllers or recorder outputs.



ATTENTION!

If the 0/4 20 mA continuous controller output is configured for an automatic controller, this can be manually adjusted to the actuator independently of the settings in the service menu - "recorder". It is possible to configure the 0 ... 20 mA controller output and a 4 ... 20 mA recorder output. It must be noticed that eventual changes in the „Service – Recorder menu“ will be reset after 20 mA outputs.

11 Log book function

The following activities are stored in the logbook:

- Configuration of the initial delivery with date and time
- changed configuration on setup with date and time
- Setting the controller parameters (Xp, Tn, Tv), basic load, restriction, setpoints, alarm parameters, and calibration data on start-up with date and time
- Changing the controller parameters (Xp, Tn, Tv), basic load, restriction, setpoints, alarm parameters, and calibration data with date and time
- Configuration of the digital inputs

These data are stored on the memory card and can be directly selected in the TOPAX or with a PC.

The software version is stored together with a file (* LOG) as text file and DATE (* DAT) as recorder file for each day.

Furthermore, the configuration can be saved.

For the installation of the memory card, refer to chapter 16.

For the handling of the logbook, refer to section "12.1.21 Menu 5.6: Logbook" on page 35.

12 Menu configuration and main settings

12.1 Menu of TOPAX

In this chapter all of the TOPAX menus are presented and their operation exemplified. As the display is in colour and high resolution, the menus are shown in text and are clearly arranged.

12.1.1 Standard display

If there are no entries in the TOPAX within 5 minutes, the device turns to the standard display.

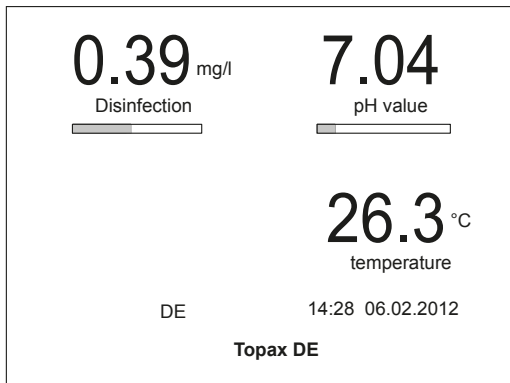

Fig.18: Standard display of TOPAX

The bars below the digits of the measurements indicate the strength of the respective output signal. The colour of the display changes, depends on the signal power, from green (0-85 %) to orange (85 – 95 %) and red (95 – 100 %).

Pressing any key takes you to the main menu (menu 1).

12.1.2 Menus 1 and 2: Main menu and sub-main menu

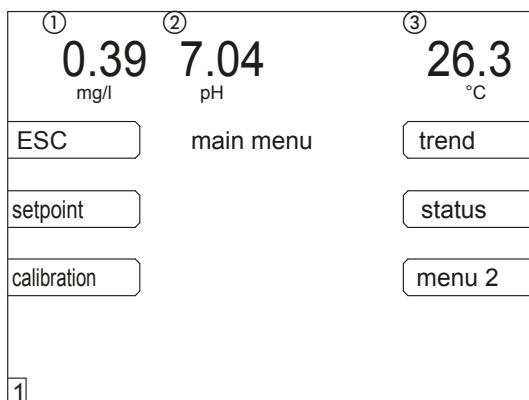

Fig.19: Menu 1: The TOPAX main menu and output point to reach all further sub-menus and their functions. With the displays for ① Disinfection, ② pH value and ③ temperature.

Menu 2 acts as a sub-main menu

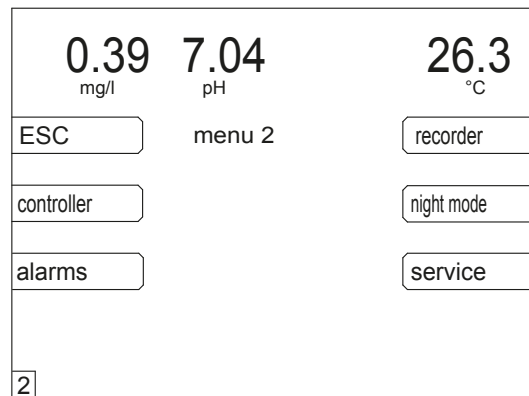

Fig.20: Menu 2: Extension of the main menu

12.1.3 Overview of the sub-menus

You can access all other sub-menus through the main menu (menu 1) and the sub-main menu (menu 2).

Menu	Key	Comment on sub-menu		
1	Main menu			
	ESC	Return to the standard display		
1.1	Target values	Sets the setpoints of the configured controllers		
1.2	Calibration	Calibration of all sensors connected to the system		
1.3	Trend	Shows measurements as line chart in various zoom stages		
1.4.1	Status	Display of all important settings		
2	Menu 2	Change to the following menus		
2	Menu 2			
	ESC	Return to the main menu		
2.1	Controller	Optimization of the parameters of all configured controllers (access to this menu can be protected by a password).		
2.2	Alarms	Assigns the alarms to the measurement signals		
23	Recorder	Sets the zooming function for the analogue outputs 0/4 ... 20 mA		
5	Service	Further adjustment options (access to this menu can be protected by a password): <table border="0" style="width: 100%;"> <tr> <td style="vertical-align: top;"> <ul style="list-style-type: none"> • Configuration • Inputs • Auto setup (not available) • Network • Time • Password • DIN contact (not available) • Alarm settings • Recorder • Display </td> <td style="vertical-align: top;"> <ul style="list-style-type: none"> • Hardware status (HW-Status) • Outputs • Reset • Logbook • Timer (not available) • Service password • Flocking (not available) • Start • Digital inputs • Language </td> </tr> </table>	<ul style="list-style-type: none"> • Configuration • Inputs • Auto setup (not available) • Network • Time • Password • DIN contact (not available) • Alarm settings • Recorder • Display 	<ul style="list-style-type: none"> • Hardware status (HW-Status) • Outputs • Reset • Logbook • Timer (not available) • Service password • Flocking (not available) • Start • Digital inputs • Language
<ul style="list-style-type: none"> • Configuration • Inputs • Auto setup (not available) • Network • Time • Password • DIN contact (not available) • Alarm settings • Recorder • Display 	<ul style="list-style-type: none"> • Hardware status (HW-Status) • Outputs • Reset • Logbook • Timer (not available) • Service password • Flocking (not available) • Start • Digital inputs • Language 			

On the following pages all sub-menus are presented in ascending order and exemplified by means of a demonstrative example.

12.1.4 Menu 1.1: Target values

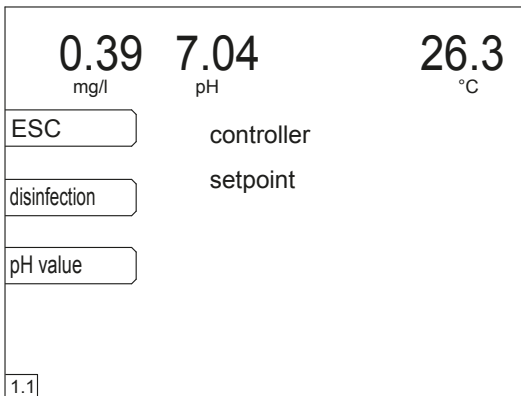

Fig.21: Main menu >> setpoint

With the menu "setpoint" each control unit assigns the desired setpoint to each output. According to the configuration the target values can be fixed for the following control units:

Menu	Controller	Key
1.1.1	Disinfection controller	Disinfection
1.1.2	Controller pH value	pH value

Select a control unit to set up the set value. The device goes to the relevant menu 1.1.1... 4.

The first digit of the set value is highlighted in grey and can be adjusted. Use the arrow keys to set up the value:

- ◀ / ▶ switch over between the individual positions
- ▲ / ▼ alter numerical values
- „OK“ Press OK to save

12.1.5 Menu 1.2: Calibration

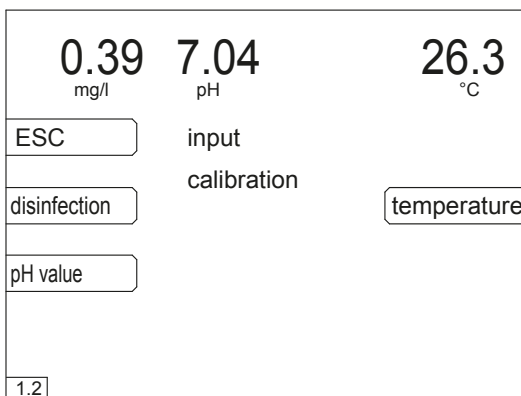

Fig.22: Main menu >> Calibration

With the Menu "Calibration" the sensors are calibrated with the inputs. According to the setting the following inputs can be selected:

Menu	Input	Key
1.2.1	Disinfection	Disinfection
1.2.2	pH value	pH value
1.2.3.3	Redox (optionally available)	Redox
1.2.4.3	Temperature	Temperature

Select one of the inputs for calibration. The device goes to the relevant menu 1.2.1... 1.2.8.3

The type of calibration (1-point calibration or 2-point calibration) depends on the attached sensor (see also chapter 5), which was defined in the start-up configuration.

Input	1-point calibration	2-point calibration
Disinfection		
Amperometric electrode	*)	Menu 1.2.1
potentialstatic electrode	Menu 1.2.1.3	
Encapsulated electrode	*)	Menu 1.2.1
pH value		
pH single-rod measuring cell - without specifications about slope rate		Menu 1.2.2
pH single-rod measuring cell - with specifications about slope rate	Menu 1.2.2	
Redox (optionally available)	Menu 1.2.3.3	
Temperature	Menu 1.2.4.3	

*) For start-up the sensors require a 2-point calibration. For inspection/post-calibration a 1-point calibration is sufficient. Therefore, menu 1.2.1 offers both types of calibration.

Please note the messages on the display. After the calibration has been selected the TOPAX requests one and/or two reference values. At this stage keep the sensor in the relevant measuring water or buffer solution.

Enter the requested reference value for the water / solution: The first digit of the set value is highlighted in grey and can be adjusted.

Use the arrow keys to set up the value:

- ◀ / ▶ switch over between the individual positions
- ▲ / ▼ alter numerical values

Confirm and save with the "OK" key.

Confirm the measuring water extraction with the "OK" key.

After the calibrating of Disinfection and pH-value the sensor's slope rate is shown.

Special feature for the calibration of the pH value

The actual voltage of the single-rod measuring cell AND the design voltage of the pH buffer solution are indicated on the display during calibration of the pH value. These two values allow the operator to monitor the accuracy of the measuring electrode.

The deviation between the measurement of the pH value with the photometer and the electrometric measurement can be compensated with the "offset compensation" option (see menu 1.2.2.6).

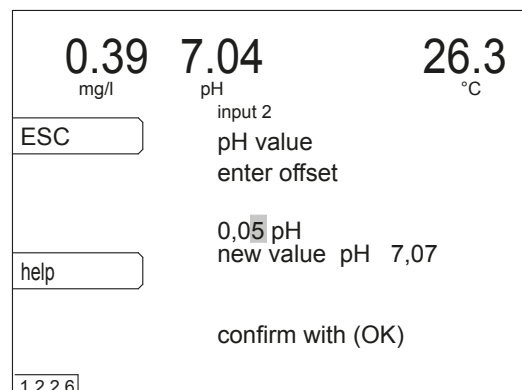

Fig.23: Main menu >> calibration >> pH value >> offset

12.1.6 Menu 1.3: Trend representations

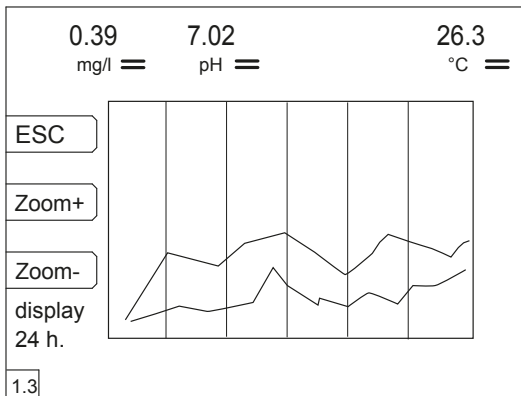

Fig.24: Main menu >> trend

The actual trend of the measurements is represented by coloured curves. These can be constructed at different time intervals. A time range of 60 minutes, 4 hours or 24 hours can be displayed. To change the desired time to a respectively bigger or smaller interval use the „Zoom +“ and „Zoom -“.

12.1.7 Menu 1.4 Status display

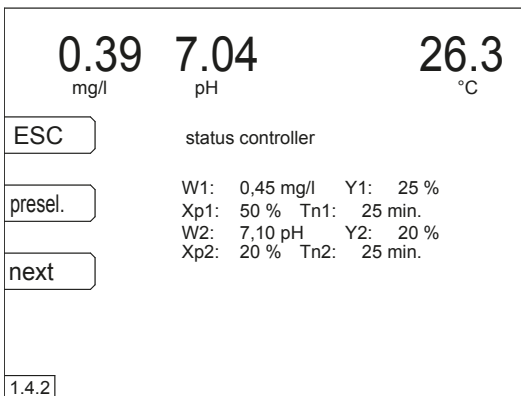

Fig.25: Main menu >> status

The status-display shows the most significant data for accurate prediction of TOPAX proper functioning.

Menu	Status displays
1.4.1	Main parameters of all configured controllers
1.4.2	Switching status of all outputs
1.4.3	Physical values and calibrated resistivity values of all inputs
1.4.4	<ul style="list-style-type: none"> used software version serial number hardware identification data input identification outputs identification number of operating hours

By pressing the “next” key, the TOPAX switches to menu 1.4.1 to 1.4.4.

Save and activate preselects

It is also possible for certain applications to save the adjusted values and activate them when needed. For these presettings several names can be allocated:

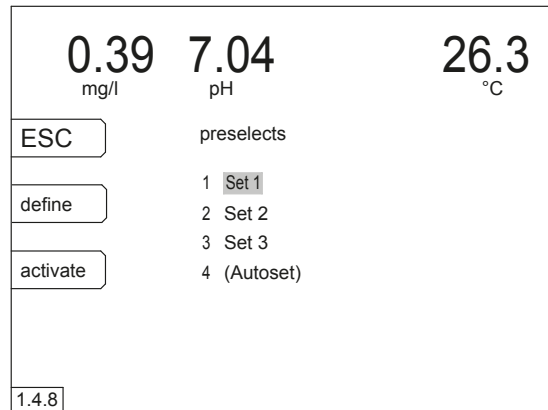

Fig.26: Main menu >> status >> presel.

Press the “presel.” key and the device switches to menu 1.4.8. Select from one of the four presettings that you want to activate or overwrite with the actual values. To select press the arrow keys ▲ and ▼.

The device goes to menu 1.4.8.1:

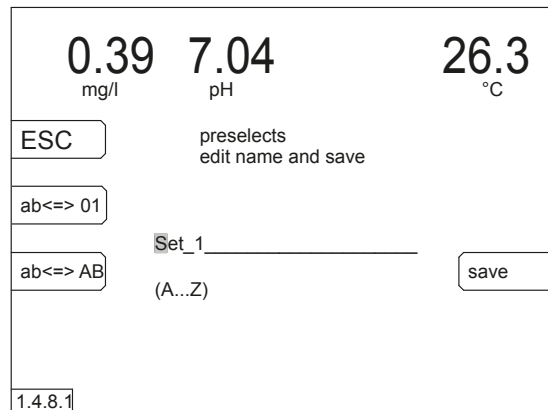

Fig.27: Main menu >> status >> presel. >> define

Enter the name of the pre-adjustment using the arrow keys ▲ and ▼.
This means:

Keys	Function
▲ and ▼:	Change individual letters and numbers
◀ and ▶:	shift cursor
ab <=> 01	change small letters to numbers/symbols
ab <=> AB	change small into capital letters

Press the "save" key to save up to this point the adjusted regulating characteristics. Confirm the procedure with the "OK" key.

The following adjustments are saved and can be re-activated at any time:

- regulating characteristics of configured controller
- set values of configured controller

12.1.8 Menu 2.1: adjust controller

0.39 mg/l	7.04 pH	26.3 °C
ESC	setup	
disinfection	controller	
pH value		
2.1		

Fig.28: Main menu >> menu 2 >> controller

The TOPAX is able to command up to four control units. The basic adjustments of every single control unit are configured in this menu:

Menu	Controller setting	Required specifications
2.1.1	Disinfection	
2.1.1.1	Control direction	boosting/dropping/2 sites
2.1.1.2	Disturbance variable	Disturbance variable, ON/OFF
2.1.1.3	overview of settings	
2.1.1.3.1	Parameter Xp	% value
2.1.1.3.2	Parameter Tn	ON or OFF + time
2.1.1.3.3	Parameter Tv	ON or OFF + time
2.1.1.4	Basic load	ON or OFF + time
2.1.1.5	Manual mode	%-value, ON/OFF, shock chlorination
2.1.2	pH value	
2.1.2.1	Control direction	boosting/dropping/2 sites
2.1.2.2	Disturbance variable	Disturbance variable, ON/OFF
2.1.2.3	overview of settings	
2.1.2.3.1	Parameter Xp	% value
2.1.2.3.2	Parameter Tn	ON or OFF + time
2.1.2.3.3	Parameter Tv	ON or OFF + time
2.1.2.4	Basic load	ON or OFF + time
2.1.2.5	Manual mode	%-value, ON/OFF

Select one of the two control units. The device goes to the relevant menu 2.1.1... 2.1.2.

Apply the adjustments relevant to your requirements in the following sub-menus to the control unit.

Adjust the parameters accordingly with the arrow keys ▲ and ▼ and confirm your entries with the "OK" key.

12.1.9 Configuring the shock chlorination (only in case of disinfection with chlorine)

For shock chlorination, the "Disinfection" controller is switched to manual operation for an adjustable time and an adjustable dosing rate. When the time has elapsed, the controller automatically switches to automatic operation.



NOTICE!

The user must empirically define the time and the dosing rate for shock chlorination before this function is performed.

0.39 mg/l	7.04 pH	26.3 °C
ESC	controller 1 disinfection	shockchl.
time	manual mode	on
%	6 min 100 % Timer 200 s	off
(OK) to store		
2.1.1.5		

Fig.29: Main menu >> menu 2 >> controller >> Disinfection >> manual >> shockchl.

The "shock chlorination" key is used at the same time for configuring and starting shock chlorination. Set the time with the "Time" key. Set the maximum output capacity with the "%" key.

Press the "OK" key to save the settings. The shock chlorination is indicated on the status display. The timer counts down and indicates the remaining time in minutes. When the time has elapsed, the system switches to automatic operation.

12.1.10 Menu 2.2: Alarms

0.39 mg/l	7.04 pH	26.3 °C
ESC	setup	
disinfection	alarms	temperature
pH value		
2.2		

Fig.30: Main menu >> menu 2 >> alarms

TOPAX monitors its inputs. If an unwanted alteration appears on an input value, the alarm is set off. The alarm-setting is configured in this menu:

Menu	Function	Required specifications
2.2.1	Disinfection	
2.2.1.1	Maximum alarm	ON or OFF + limit value
2.2.1.2	Minimum Alarm	ON or OFF + limit value
2.2.1.3	Y alarm	ON or OFF + time
2.2.1.4	Alarm delay	ON or OFF + time
2.2.2	pH value	
2.2.2.1	Maximum alarm	ON or OFF + limit value
2.2.2.2	Minimum Alarm	ON or OFF + limit value
2.2.2.3	Y alarm	ON or OFF + time
2.2.2.4	Alarm delay	ON or OFF + time
2.2.4	Temperature	
2.2.4.1	Maximum alarm	ON or OFF + limit value
2.2.4.2	Minimum Alarm	ON or OFF + limit value
2.2.4.4	Alarm delay	ON or OFF + time

Select one of the inputs. The device goes to the relevant menu 2.2.2... 2.2.4 and shows the actual configuration of the input alarm.

Select one of the (up to) four available alarm functions of the input for configuration.

Alarm	Alarm is set off, if ...	Key
Maximum measuring value	Input value > max. value	max alarm
Minimum measuring value	Input value < min. value	min alarm
Y alarm	after a given time for the input of the relevant control unit in the computer's output service is > 95%.	Y alarm
Alarm delay	the alarm's delay time has run out	Delay

Press on "OFF" to turn off the chosen alarm function. Confirm twice with the "OK" key.

Press on "ON" to turn the chosen alarm function on.

Enter the requested limit value.

The first digit of the limit value is highlighted in grey and can be adjusted. Use the arrow keys to set up the value:

◀ / ▶ switch over between the individual positions

▲ / ▼ alter numerical values

Confirm the entry by pressing the "OK" key twice.

12.1.11 Menu 2.3: Recorder (analogue outputs 0/4 ... 20 mA)

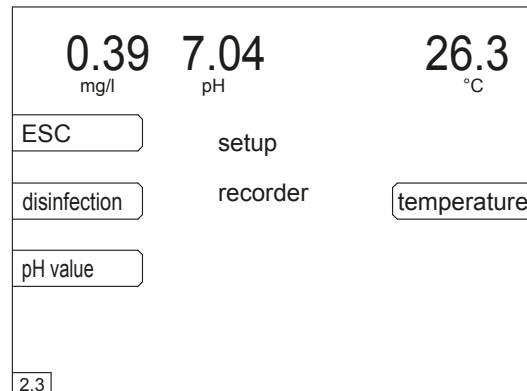

Fig.31: Main menu >> menu 2 >> recorder

For remote display of measured values, TOPAX has an analogue output 0/4 ... 20 mA, named "recorder output", for each measured value input.

This menu is used for the adjustment of the TOPAX to the external devices which are connected to the outputs. An allocation / standardisation takes place between each measured value input and analogue output:

Minimum measurement input = 0/4 mA

Maximum measurement input = 20 mA

There are recorder outputs for the inputs:

Menu	Inputs	Key	Required input	Unit
2.3.1	Disinfection	Disinfection	Minimum, Maximum	mg/l
2.3.2	pH value	pH value	Minimum, Maximum	pH
2.3.4	Temperature	Temperature	Minimum, Maximum	°C

Select an input for standardisation of the analogue output. Select "Minimum" or "Maximum" to define the lower limit or respectively the upper limit of the measured value.

Enter the requested limit value.

The first digit of the limit value is highlighted in grey and can be adjusted. Use the arrow keys to set up the value:

◀ / ▶ switch over between the individual positions

▲ / ▼ alter numerical values

Confirm the entry by pressing the "OK" key twice.

12.1.12 Menu 2.4: Night operation

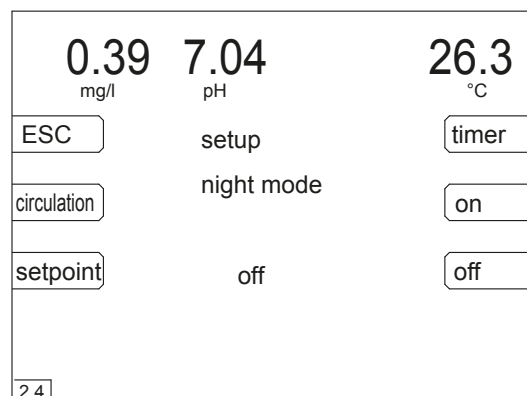

Fig.32: Main menu >> menu 2 >> night operation

For night-time operation:

- only useful in a closed circuit.
- it can be manually switched on and off.
- the target value for the controller has to be defined.
- the percentage value can be set for reduction of recirculation power.
- Configuring the timer is not possible.

12.1.13 Menu 5: Service

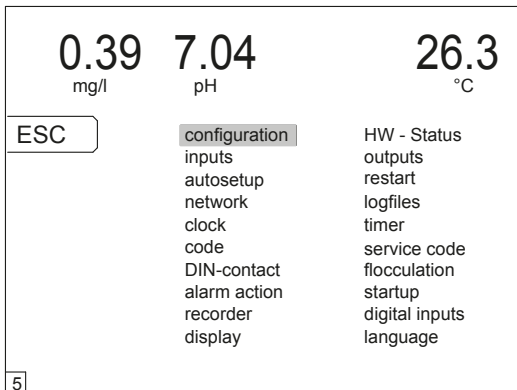

Fig.33: Main menu >> menu 2 >> service

The Menu 5 “Service” covers 20 functions for the basic setting of the TOPAX (not all functions are available):

Menu	Key	Function
0.4.4	Configuration	Repeat basic configuration Saving and loading of a configuration
5.01	Hardware status	Hardware/software equipment
5.1	Inputs	Adjusting the input measuring ranges
5.2	Outputs	Outputs settings
53	Auto setup	not available
5.4	Reset	Reset and factory settings
5.5	Network	Configuration of RS 485 network address (optionally available)
5.6	Logbook	Write/read the logbook
5.7	Time	Setting of date and time
5.8	Timer	not available
5.9	Password	Definition of an access code for the individual menus
5.10	Service password	Setting an access code for menu 5 "service"
5.11	DIN contact	not available
5.12	Flocculation	not available
5.13	Alarm settings	Configuration of alarm settings
5.14	Start	Setting the start delay
5.15	Recorder	0...20 mA/4...20 mA or test signal selection
5.16	Digital inputs	Digital input settings
5.17	Display	Display settings
5.18	Language	Change language and units

The various menus are described in the following pages.

To select the menus press the arrow keys ►, ◀, ▲ and ▼. Confirm the selection with “OK”.

12.1.14 Menu 0.4.0: Configuration

The configuration of TOPAX can be changed, saved and loaded. Existing configuration files are saved on the memory card or loaded from it.

Main menu >> menu 2 >> service >> configuration ...

- ... >> edit Menu 0.4
- ... >> Load Menu 0.4.20, select an existing configuration with the ▲ and ▼ keys and confirm with "OK".
- ... >> save Menu 0.4.21, save the current configuration to the memory card. The file name can be chosen freely.

In this way, the configuration of the TOPAX can for instance be done for several control circuits once and then be transferred to other, identical TOPAX controllers via the memory card. All settings are transferred.

Furthermore, the configuration files can be saved on a PC and transferred to an identical TOPAX if required.

12.1.15 Menu 0.4.1: Configuration

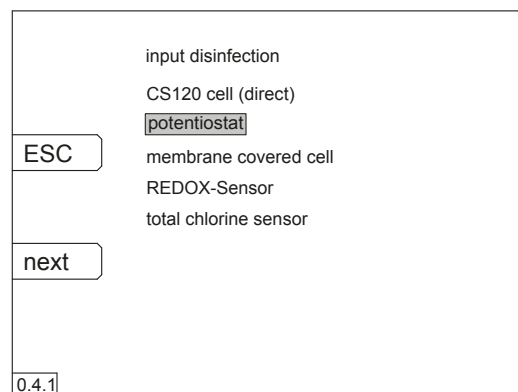

Fig.34: Main menu >> menu 2 >> service >> configuration >> edit

IMPORTANT!
The disinfection input will be preset before delivery according to the order and can no longer be changed.

The configuration of inputs and outputs can be modified if necessary. Before it is saved, the newly set configuration is indicated in red and must be saved. Use the "ESC" button to exit the menu without saving and return to the old configuration.

When the new configuration is saved, check the terminals as well. The new wiring diagram is displayed. The changed terminals are shown in red writing. The terminal plan must be confirmed.

Inadmissible configurations are blocked. A text error message is shown. For control purposes the terminal layout and assignments can be seen in menu 5.01 “Hardware status”.

All TOPAX versions are supplied with a measuring protocol and a terminal connection diagram referred to the actual configuration.

12.1.16 Menu 5.0.1: hardware status

Main menu >> menu 2 >> service >> HW status

The menu of the TOPAX indicates:

- Software version
- Runtime
- Integrated components
- Terminal connection
- Hardware status

12.1.17 Menu 5.1: Inputs

Main menu >> menu 2 >> service >> inputs

Input	Functions
Disinfection	Defining the measurement ranges for the configured sensor and switching on the measured value compensation for the pH value and chlorine (Compensation of the chlorine value is only possible for the measurement with a potentiostatic measuring cell)

12.1.18 Menu 5.2: Outputs

Main menu >> menu 2 >> service >> outputs

The menu permits:

- Adjusting the parameters for the current configured type of output
- Adjusting the maximum limits for the outputs.

12.1.19 Menu 5.4: Reset

Main menu >> menu 2 >> service >> reset

The menu permits

- Reset: Reset the device using the same configuration
- Factory setting: Restart the instrument using the original default settings (see chapter "13 Default settings" on page 37).
- The controller is switched off in a defined manner before being disconnected from the power supply.

12.1.20 Menu 5.5: Network

Main menu >> menu 2 >> service >> network

The menu permits the RS 485 network address to be set to connect the controller to a PC or network (see chapter "4.4.5 Interface board RS 485" on page 8).

12.1.21 Menu 5.6: Logbook

Main menu >> menu 2 >> service >> log file

The data logger contains the full list of all settings done on your TOPAX. It can be viewed as clear text on your TOPAX screen or on your PC but in this case you must replace the existing memory card (see chapter "14 Memory card" on page 37).

12.1.22 Menu 5.7: Time

Main menu >> menu 2 >> service >> time

Menu for setting the time after a battery replacement.

The time automatically changes from summer time to winter time and vice versa. This menu also allows you to switch off this changeover function.

12.1.23 Menus 5.9 and 5.10: Code und service password

Main menu >> menu 2 >> service >> password and service password

In these menus you can block the various levels by using a password (a 4-digit numerical code). All information menus remain available.

The password is activated 5 minutes after input.

Menu	Function
5.9 Password	When the password has been entered, the "Calibrate", "Setpoints" and "Menu 2" menus can only be accessed by entering this password.
5.10 Service password	When a service password has been entered the "Service" menu can only be accessed by entering this password.

If no password is set all program levels are accessible.



ATTENTION!

If you enter a protection code, the related menu will be only accessible after entering the password. Enter the password and press "OK" to confirm.

12.1.24 Menu 5.13: Alarm settings

Main menu >> menu 2 >> service >> alarm settings

Use this menu to set the controller pattern and the alarm relay function when an alarm occurs.

- Controller ON: the controller remains on if an alarm sounds
- Controller OFF: the controller goes off when an alarm sounds and the control valve is closed
- Relay ON: the alarm relay is activated when an alarm is activated
- Relay OFF: the relay is activated when energized by the operating current and is deactivated if an alarm goes on.

12.1.25 Menu 5.14: Start

Main menu >> menu 2 >> service >> startup

In this menu you can adjust the lag time of the control functions. The new time is effective after you have successfully:

- calibration of the individual sensors
- measuring water shortage
- Filter cleaning
- after switching the power on

12.1.26 menu 5.15: Recorder outputs

Main menu >> menu 2 >> service >> recorder

In this menu you can set the analogue outputs (recorder outputs) between 0 .. 20 mA or 4 .. 20 mA to transfer the measurements and to test with an adjustable test signal.

12.1.27 Menu 5.16: Digital switch inputs

Main menu >> menu 2 >> service >> digital inputs

Menu for switching on and activating the digital inputs. They can be defined as "normally ON" or "normally OFF". If not assigned, the digital inputs used for the level switch of the dosing container (to switch off the free-chlorine or the ph controller) can be also set to "not active".

12.1.28 menu 5.17: Display

Main menu >> menu 2 >> service >> display

The menu permits:

- Assigning a system name on the display
- Switching on / off additional information on the standard display
- Setting the brightness of the display.

12.1.29 Menu 5.18: Language

Main menu >> menu 2 >> service >> language

User language setting menu. You can activate additional languages from the memory card (see chapter "4.11.3 Further languages - Memory card" on page 17).

13 Default settings

The default configuration by the manufacturer includes the following settings. The inputs are activated according to the part number.

<ul style="list-style-type: none"> • Y-Alarm (safety stop) works for all controllers and lasts 60 minutes • Start-up lag time: Time 60 seconds • all measuring alarm values are deactivated • all special functions are deactivated 		
Digital signals <ul style="list-style-type: none"> • measuring water alarm: • ON when the contact is opened • night-time reduced operation • ON when the contact is closed • Level inputs: Input not active 		
Input Disinfection	In the as-delivered state	
Disturbance factor input		
Output Disinfection	Servomotor with potentiometer	
pH output	Pulse frequency (optocoupler) 100 pulses/min	
Disinfection controller	W: 0.50 mg/l Xp: 35 % Tn: 15 minutes Tv: OFF	
Controller pH value	W: pH 7,10 Xp2: 10 % Tn2: 15 minutes Tv2: OFF	

14 Memory card

The memory card transfers and stores language data and logfiles.

The data which is saved on the card can be transferred to a PC by means of a reading device. To remove the memory card, the TOPAX must be switched off in a specific way: press the "Switch Off" key in the "Service-reset" menu. All controllers are set to an output capacity of "0%" and all unsaved data is saved to the memory card. The TOPAX can continue to operate without the card.

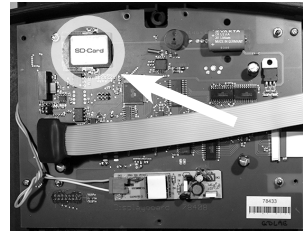

Fig.35: Slot for the memory card on the display board. The card is inserted on the display circuit board in the front housing.



ATTENTION!

The memory card must only be inserted or removed when the device is de-energised. Switch off the TOPAX in the "Service-reset" menu.

On its website, the manufacturer provides the free software "TopReader" to read the memory card with the recorder and configuration data.

ATTENTION!

Make sure that no additional data is saved on the memory card and that the saved data is not modified (data loss). The memory card must only be formatted in "FAT" format.

15 Troubleshooting and diagnostics

All errors are indicated in clear text on the display of the TOPAX. If several errors occur simultaneously, the error messages can be viewed with the ▲ and ▼ keys. The following error displays and messages are possible:

15.1 Self-setting alarms

Display	Reason	Reactions of TOPAX	
		Alarm relay	Controller output 0%
System start		Not activated	Yes (all)
Keyboard locked	Keyboard lock is ON (max. 60 sec)	Not activated	No
Sensor alarm	Input power < 4mA Input power > 21mA or faulty input module	Activated	Yes – Input allocated
"measurand" not calibrated	Calibrate corresponding input	Not activated	No (the measurement input works with standard values)
"measurand" calibration not OK	The corresponding input cannot be calibrated to the requirements	Not activated	No
Faulty potentiometer compensation "measurand"	3 point step-by-step controller position feedback: no calibration performed	Not activated	Yes
Manual mode	manually started	Not activated	
measuring water shortage (not during calibration)	water is not enough through-flow contact is defective	Activated	Yes (all)
Night-time economy mode	Night time economy mode activated	Not activated	
Low level alert	Chemicals container is nearly empty	Activated	No
Level main alarm	Chemicals container empty	Activated	Yes

15.2 Displays that must be confirmed with "OK"

Display	Reason	Reactions of TOPAX	
		Alarm relay	Controller output 0%
Max alarm	Set measurement exceeded	Activated	configurable
Min alarm	Measurement below set level	Activated	configurable
Y alarm	Safety cutout (see item 9.2)	Activated	configurable

15.3 Remedy

Display	Reason	Remedy
System start		System restores itself to normal operation after delay
Keyboard locked	Keyboard lock is ON (max. 60 sec)	System restores itself to normal operation after delay
Sensor alarm	Input power < 4mA Input power > 21mA or faulty input module	<ul style="list-style-type: none"> Check sensor connection Replace input module
"measurand" not calibrated	corresponding input not calibrated	Calibrate corresponding input
"measurand" calibration not OK	<ul style="list-style-type: none"> Insufficient measuring cell transconductance Excessive zero point drift 	Buffer solution not ok, or replace measuring cell
	Sensor or single-rod measuring cell not compliant with DIN standards	Check and replace measuring input sensor if necessary
	Defective input module	Check and replace the input module if necessary
Faulty potentiometer calibration	3 point step-by-step controller position feedback: no calibration performed	Perform a position feedback calibration in the "outputs" menu
measuring water shortage	water is not enough or through-flow contact is defective	<ul style="list-style-type: none"> Increase sample water flow Check through-flow contact
Low level alert	Chemicals container is nearly empty	Add chemical agents or change container
Level main alarm	Chemicals container empty	Add chemical agents or change container
Max alarm	Set measurement exceeded	<ul style="list-style-type: none"> Check measurement or sensor Check controller parameter setting
Min alarm	Measurement below set level	
Y alarm	Safety cutout (see item 9.2)	
Servo motor alarm	Servo motor has not reached the end position and/or the zero point	Check servo motor

16 terminal connection diagram for own configurations

Select here your connection requirement for terminal clips configuration of your TOPAX.

Part.-no.: _____

Description	Part number	assembled
input module 5-fold		
input module 3-fold		
Output board		
PC interface - RS 485		

16.1 measurands

		Terminal connection clips	
		Input	20 mA power outputs
Disinfection	CS120		
	Potentiostat		
	Encapsulated electrode		
pH value			
Temperature			
Total chlorine			

16.2 Output types

16.2.1 Output Disinfection

Types of output)	Terminal connection clips	
Servomotor with potentiometer	Motor	
	Potentiometer with position feedback	
Servo motor without potentiometer		
Pulse frequency (Optocoupler)		
Pulse frequency (relay)		
Pulse length (relay)		
Continuous regulating output 0/4...20 mA		
ON/OFF (relay)		
No controller function		

16.2.2 pH output

Types of output)	Terminal connection clips	
Servomotor with potentiometer	Motor	
	Potentiometer with position feedback	
Servo motor without potentiometer		
Pulse frequency (Optocoupler)		
Pulse frequency (relay)		
Pulse length (relay)		
Continuous regulating output 0/4...20 mA		
2-sides pulse frequency (optocoupler)		
2-sides pulse frequency (relay)		
2-sides pulse length (relay)		
ON/OFF (relay)		
No controller function		

16.2.3 Digital inputs

(„Service“ menu – digital inputs)

Function	Terminal connection clips		Configured	
measuring water shortage	17, 18		„OK“ = closed	
			„OK“ = opened	
Dosing tank Disinfection	Level – warning	Level – alarm		
	21, 22	23, 24	„OK“ = closed	
			„OK“ = opened	
			Not active	
chemical tank pH value	Level – warning	Level – alarm		
	25, 26	27, 28	„OK“ = closed	
			„OK“ = opened	
			Not active	

17 Device revision

This operating manual applies to the following devices:

Device and model	Revision status	Software Version:
TOPAX	1/2013	1.25 onwards

Language file	Software	Version	Languages
1.26 onwards	1.27 onwards	1/2013	DE, EN, ES, PT, NL, FR, CZ, RU, NO, PL

It contains all the technical information required for installation, start-up and maintenance. Should you have any questions or require further information regarding this operating manual, please contact the manufacturer or its official national representative.

18 Warranty claim

Warranty claim

Please copy and send it back with the unit!

If the device breaks down within the period of warranty, please return it in a cleaned condition with the complete warranty claim.

Sender

Company: Phone: Date:

Address:

Contact person:

Manufacturer order no.: Date of delivery:

Device type: Serial number:

Nominal capacity / nominal pressure:

Description of fault:.....

.....

.....

.....

.....

.....

.....

.....

.....

Service conditions of the device

Point of use / system designation:.....

.....

.....

Accessories used (suction line etc.):.....

.....

.....

.....

.....

Commissioning (date):

Duty period (approx. operating hours):

Please describe the specific installation and enclose a simple drawing or picture of the chemical feed system, showing materials of construction, diameters, lengths and heights of suction and discharge lines.

19 EC Declaration of Conformity



EU-Konformitätserklärung

Der Unterzeichnete Lutz-Jesco GmbH, Am Bostelberge 19, 30900 Wedemark, bestätigt, dass die nachfolgend bezeichneten Geräte in der von uns in Verkehr gebrachten Ausführung die Anforderungen der harmonisierten EU-Richtlinien, EU-Sicherheitsstandards und produktspezifischen Standards erfüllen. Bei einer nicht mit uns abgestimmten Änderung der Geräte verliert diese Erklärung ihre Gültigkeit.

(EN) EU Certificate of Conformity

The undersigned Lutz-Jesco GmbH, Am Bostelberge 19, 30900 Wedemark, hereby certifies that, when leaving our factory, the units indicated below are in accordance with the harmonised EU guidelines, EU standards of safety and product specific standards. This certificate becomes void if the units are modified without our approval.

(FR) Certificat de conformité aux directives européennes

Le constructeur, soussigné: Lutz-Jesco GmbH, Am Bostelberge 19, 30900 Wedemark, déclare qu'à la sortie de ses usines le matériel neuf désigné ci-dessous était conforme aux prescriptions des directives européennes énoncées ci-après et conforme aux règles de sécurité et autres règles qui lui sont applicables dans le cadre de l'Union européenne. Toute modification portée sur ce produit sans l'accord express de Jesco supprime la validité de ce certificat.

(ES) Declaración de conformidad de la UE

El que suscribe Lutz-Jesco GmbH, Am Bostelberge 19, 30900 Wedemark, declara que la presente mercancía, objeto de la presente declaración, cumple con todas las normas de la UE, en lo que a normas técnicas, de homologación y de seguridad se refiere, En caso de realizar cualquier modificación en la presente mercancía sin nuestra previa autorización, esta declaración pierde su validez.

(NL) EU-overeenstemmingsverklaring

Ondergetekende Lutz-Jesco GmbH, Am Bostelberge 19, 30900 Wedemark, bevestigt, dat het volgende genoemde apparaat in de door ons in de handel gebrachte uitvoering voldoet aan de eis van, en in overeenstemming is met de EU-richtlijnen, de EU-veiligheidsstandaard en de voor het product specifieke standaard. Bij een niet met ons afgestemde verandering aan het apparaat verliest deze verklaring haar geldigheid.

(HU) EG (EK)– Egyezőségi nyilatkozat

A Lutz-Jesco GmbH, Am Bostelberge 19, 30900 Wedemark ezúton kijelenti, hogy a szóban forgó termék annak tervezése és szerkezeti módja, valamint forgalomba hozott kivitele alapján a vonatkozó alapvető biztonság technikai és egészségügyi követelményeknek és az alábbi felsorolt EG –irányelveknek minden szempontból megfelel. A terméken engedélyünk nélkül végrehajtott módosítások következtében jelen nyilatkozat érvényét veszíti.

Bezeichnung des Gerätes:	Mess- und Regeleinheit
Description of the unit:	Measuring and control unit
Désignation du matériel:	Mesure et regulationm
Descripción de la mercancía:	Medicion y control
Omschrijving van het apparaat:	Meet- en regelsysteem
A termék megnevezése:	Méro- és szabályozó egység

Typ / Type / Tipo / Típusjelölés:

TOPAX DE
TOPAX L

EU-Richtlinie / EU directives/
Directives européennes / Normativa UE /
EU-richtlijnen / Vonatkozó EG-irányelvek

2006/95/EG
2004/108/EG

Harmonisierte Normen / harmonized
standards / Normes harmonisées /
Estándares acordemente / Toegepaste
normeringen / Hatályos normák

EN 61000-6-2 : 2005
EN 55011:1998 + A1:1999 + A2:2002

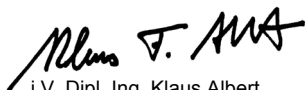

i.V. Dipl. Ing. Klaus Albert
Lutz-Jesco, Wedemark, 01.02.2008

Technische Leitung / Technical Departement Manager / Direction technique /
Dirección Técnica / Hoofd technische dienst / Műszaki irodavezető

20 Index

A

actual value (X)	25
Alarm delay	33
Alarms	27
Alarm settings	27, 35

B

Basic load dosing	27
Battery	10

C

“poorly calibrated”	19
Calibration Disinfection	20
Calibration pH value	30
Calibration redox potential	23
Calibration temperature	30
Control deviation (X-W)	25
Control direction	27
Controller / 3-point-step	24
Controller continuous output	25
Controller pulse frequency	24
Controller pulse length	24
Control variable Y	25
CS120	20

D

Data line	9
Date and time	28
Default settings	37
Derivative time Tv	26
Digital signal inputs	24
Digital switch inputs	35
Dimensions	5

E

Electronic output	24
Encapsulated electrode	21
Error messages	38

G

General technical data	5
------------------------------	---

H

Hardware status	35
Housing	7

I

Inputs module	8
Installation	7

K

Key layout	17
------------------	----

L

Language	36
Level dosing pump	24
Level inputs	24
Logbook	28

M

Manual mode	27
Measurement input Disinfection	20
measuring water shortage	24
Menu structure	29
Motor life	25

N

Network address	35
-----------------------	----

O

ON/OFF controller	24
Optocoupler output	24
Output board	8
Output restriction	25

P

Password	35
PC interface	8
pH value	21
pH value measurement input	21
PI or PID controller	25
Potentiostat	20
Proportional range Xp	25
Pulse length	24

R

Redox measurement input	23
REDOX potential	23
Relay output	24
Reset	35
Reset time Tn	25

S

Safety cutout	27
Safety notices	3
Sensor technology	10
Service password	35
Setpoint (W)	25
Shock chlorination	32
Start-up delay	24
Status displays	31

T

Temperature	23
Temperature compensation	21
Temperature measurement input	23
Terminal plans	11
Time	35
Trend representations	31

W

Wall assembly	7
---------------------	---

